

## 3G-SDI VIDEO SWITCHER V-1SDI

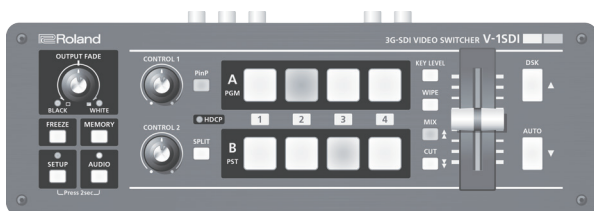

Owner's Manual Version 1.5 and later



### Owner's Manual (this document)

Read this first. It explains the basic things you need to know in order to use the V-1SDI.



### PDF Manual (download from the Web)

- **Remote Control Guide**

This manual covers remote control of the V-1SDI via MIDI, menu items, and RS-232 commands.



### To obtain the PDF manual

1. Enter the following URL in your computer.

<https://proav.roland.com/>



2. Go to the V-1SDI product page and click the "Support."

Before using the V-1SDI, ensure that its system program is at the most recent version. For information on available upgrades for the system program, see the Roland website (<https://proav.roland.com/>). You can check the system program version by pressing and holding the [SETUP] button → "VERSION" at the SETUP menu (page 16/16).

# Contents

<b>USING THE UNIT SAFELY</b> .....	<b>3</b>	<b>Video Composition Operations</b> .....	<b>22</b>
<b>IMPORTANT NOTES</b> .....	<b>5</b>	Selecting a Composition Type .....	<b>22</b>
<b>Panel Descriptions</b> .....	<b>6</b>	Compositing Four Video Pictures into One Screen .....	<b>22</b>
Top Panel/Front Panel .....	<b>6</b>	Compositing Using Picture-in-Picture .....	<b>23</b>
Rear Panel (Connecting Your Equipment) .....	<b>8</b>	Compositing Using Split .....	<b>24</b>
Side Panel (Connecting Your Equipment) .....	<b>10</b>	Compositing Using DSK.....	<b>24</b>
<b>Basic Operation</b> .....	<b>11</b>	<b>Audio Operations</b> .....	<b>26</b>
Turning the Power On and Off .....	<b>11</b>	Adjusting the Volume Level .....	<b>26</b>
Turning Off the Power Automatically (Auto Off) .....	<b>11</b>	Applying Effects to Audio .....	<b>27</b>
Using the Menus.....	<b>12</b>	Applying Effects to Input Audio .....	<b>27</b>
Saving/Recalling Settings (Memory) .....	<b>13</b>	Applying Effects to Output Audio .....	<b>28</b>
<b>Video Input/Output Settings</b> .....	<b>14</b>	Interlinking Audio Output to Video Switching (Audio Follow) ..	<b>29</b>
Setting the Video Input/Output Format .....	<b>14</b>	<b>Other Features</b> .....	<b>30</b>
Adjusting Output Video.....	<b>15</b>	Returning Settings to the Factory- default State (Factory Reset) .....	<b>30</b>
Adjusting HDMI Input Video on Channel 4 .....	<b>15</b>	Preventing Unintended Operation (Panel Lock) ..	<b>30</b>
Assigning a Video Source to Channel 3 .....	<b>16</b>	Operating the V-1SDI by Remote Control .....	<b>31</b>
Switching the View Mode of Preview Output .....	<b>16</b>	<b>Appendices</b> .....	<b>32</b>
Inputting Copyright-protected (HDCP) Video ...	<b>17</b>	Troubleshooting .....	<b>32</b>
<b>Video Operations</b> .....	<b>18</b>	Transition Effects List .....	<b>33</b>
Switching the Video .....	<b>18</b>	Block Diagram.....	<b>34</b>
About the Operation Mode for Video Transitions .....	<b>18</b>	Main Specifications .....	<b>36</b>
Switching Using the PGM/PST Mode.....	<b>18</b>	Dimensions .....	<b>37</b>
Switching in the A/B Mode .....	<b>19</b>		
Switching Automatically (Auto Scan).....	<b>20</b>		
Freezing Input Video (Freeze).....	<b>20</b>		
Applying a Fade to the Main Output Video (Output Fade) ..	<b>21</b>		
Capturing a Still Image from Input Video .....	<b>21</b>		

Before using this unit, carefully read "USING THE UNIT SAFELY" (p. 3) and "IMPORTANT NOTES" (p. 5). After reading, keep the document(s) including those sections where it will be available for immediate reference.

## Checking the Included Items

The V-1SDI includes the following items. Please take a moment to confirm that all of these items have been included with the V-1SDI. If you find that any item is missing, contact the nearest authorized Roland distributor in your country.

**The Unit**



**AC Adaptor/Power Cord**



**Cord Hook**



**Owner's Manual**





\* The shape of the power cord's plug varies depending on the country.







# USING THE UNIT SAFELY

## INSTRUCTIONS FOR THE PREVENTION OF FIRE, ELECTRIC SHOCK, OR INJURY TO PERSONS

### About WARNING and CAUTION Notices

 <b>WARNING</b>	Used for instructions intended to alert the user to the risk of death or severe injury should the unit be used improperly.
 <b>CAUTION</b>	Used for instructions intended to alert the user to the risk of injury or material damage should the unit be used improperly. * Material damage refers to damage or other adverse effects caused with respect to the home and all its furnishings, as well to domestic animals or pets.

### About the Symbols

	The  symbol alerts the user to important instructions or warnings. The specific meaning of the symbol is determined by the design contained within the triangle. In the case of the symbol at left, it is used for general cautions, warnings, or alerts to danger.
	The  symbol alerts the user to items that must never be carried out (are forbidden). The specific thing that must not be done is indicated by the design contained within the circle. In the case of the symbol at left, it means that the unit must never be disassembled.
	The  symbol alerts the user to things that must be carried out. The specific thing that must be done is indicated by the design contained within the circle. In the case of the symbol at left, it means that the power-cord plug must be unplugged from the outlet.

## ALWAYS OBSERVE THE FOLLOWING

### WARNING

#### To completely turn off power to the unit, pull out the plug from the outlet

Even with the power switch turned off, this unit is not completely separated from its main source of power. When the power needs to be completely turned off, turn off the power switch on the unit, then pull out the plug from the outlet. For this reason, the outlet into which you choose to connect the power cord's plug should be one that is within easy reach and readily accessible.



#### Concerning the Auto Off function

On this unit, the power is automatically turned off after a predetermined amount of time has passed since an operation was performed (Auto Off function). If you do not want the power to be turned off automatically, disengage the Auto Off function (p. 11).



#### Do not disassemble or modify by yourself

Do not carry out anything unless you are instructed to do so in the owner's manual. Otherwise, you risk causing malfunction.



#### Do not repair or replace parts by yourself

Refer all servicing to your retailer, the nearest Roland Service Center, or an authorized Roland distributor, as listed on the "Information."



#### Do not place in an unstable location

Otherwise, you risk injury as the result of the unit toppling over or dropping down.



### WARNING

#### Do not use or store in the following types of locations

- Subject to temperature extremes (e.g., direct sunlight in an enclosed vehicle, near a heating duct, on top of heat-generating equipment); or are
- Damp (e.g., baths, washrooms, on wet floors); or are
- Exposed to steam or smoke; or are
- Subject to salt exposure; or are
- Exposed to rain; or are
- Dusty or sandy; or are
- Subject to high levels of vibration and shakiness; or are
- Placed in a poorly ventilated location.



#### Use only the supplied AC adaptor and the correct voltage

Be sure to use only the AC adaptor supplied with the unit. Also, make sure the line voltage at the installation matches the input voltage specified on the AC adaptor's body. Other AC adaptors may use a different polarity, or be designed for a different voltage, so their use could result in damage, malfunction, or electric shock.



#### Use only the supplied power cord

Use only the attached power cord. Also, the supplied power cord must not be used with any other device.



#### Do not bend the power cord or place heavy objects on it

Otherwise, fire or electric shock may result.



#### Avoid extended use at high volume

Use of the unit at high volume for extended periods of time may cause hearing loss. If you ever experience any hearing loss or ringing in the ears, you should immediately stop using the unit and consult a specialized physician.



## USING THE UNIT SAFELY

### WARNING

#### **Do not allow foreign objects or liquids to enter unit; never place containers with liquid on unit**

Do not place containers containing liquid (e.g., flower vases) on this product. Never allow foreign objects (e.g., flammable objects, coins, wires) or liquids (e.g., water or juice) to enter this product. Doing so may cause short circuits, faulty operation, or other malfunctions.



#### **Turn off the unit if an abnormality or malfunction occurs**

Immediately turn the unit off, remove the AC adaptor from the outlet, and request servicing by your retailer, the nearest Roland Service Center, or an authorized Roland distributor, as listed on the "Information" when:



- The AC adaptor or the power cord has been damaged; or
- If smoke or unusual odor occurs; or
- Objects have fallen into, or liquid has been spilled onto the unit; or
- The unit has been exposed to rain (or otherwise has become wet); or
- The unit does not appear to operate normally or exhibits a marked change in performance.

#### **Be cautious to protect children from injury**

Always make sure that an adult is on hand to provide supervision and guidance when using the unit in places where children are present, or when a child will be using the unit.



#### **Do not drop or subject to strong impact**

Otherwise, you risk causing damage or malfunction.



#### **Do not share an outlet with an unreasonable number of other devices**

Otherwise, you risk overheating or fire.



#### **Do not use overseas**

Before using the unit in overseas, consult with your retailer, the nearest Roland Service Center, or an authorized Roland distributor, as listed on the "Information."



### CAUTION

#### **When disconnecting the power cord, grasp it by the plug**

To prevent conductor damage, always grasp the power cord by its plug when disconnecting it from this unit or from a power outlet.



#### **Periodically clean the power plug**

An accumulation of dust or foreign objects between the power plug and the power outlet can lead to fire or electric shock.



At regular intervals, be sure to pull out the power plug, and using a dry cloth, wipe away any dust or foreign objects that may have accumulated.

### CAUTION

#### **Disconnect the power plug whenever the unit will not be used for an extended period of time**

Fire may result in the unlikely event that a breakdown occurs.



#### **Route all power cords and cables in such a way as to prevent them from getting entangled**

Injury could result if someone were to trip on a cable and cause the unit to fall or topple.



#### **Avoid climbing on top of the unit, or placing heavy objects on it**

Otherwise, you risk injury as the result of the unit toppling over or dropping down.



#### **Never connect/disconnect a power plug if your hands are wet**

Otherwise, you could receive an electric shock.



#### **Disconnect all cords/cables before moving the unit**

Before moving the unit, disconnect the power plug from the outlet, and pull out all cords from external devices.



#### **Before cleaning the unit, disconnect the power plug from the outlet**

If the power plug is not removed from the outlet, you risk receiving an electric shock.



#### **Whenever there is a threat of lightning, disconnect the power plug from the outlet**

If the power plug is not removed from the outlet, you risk receiving an electric shock.



#### **Keep small items out of the reach of children**

To prevent accidental ingestion of the parts listed below, always keep them out of the reach of small children.



- Included Parts: Cord Hook (p. 2)
- Removable Parts: Screw (p. 9, 10)

#### **Handle the ground terminal carefully**

If you remove the screw from the ground terminal, be sure to replace it; don't leave it lying around where it could accidentally be swallowed by small children. When refastening the screw, make that it is firmly fastened, so it won't come loose.



# IMPORTANT NOTES

## Power Supply

- Do not connect this unit to same electrical outlet that is being used by an electrical appliance that is controlled by an inverter or a motor (such as a refrigerator, washing machine, microwave oven, or air conditioner). Depending on the way in which the electrical appliance is used, power supply noise may cause this unit to malfunction or may produce audible noise. If it is not practical to use a separate electrical outlet, connect a power supply noise filter between this unit and the electrical outlet.
- The AC adaptor will begin to generate heat after long hours of consecutive use. This is normal, and is not a cause for concern.

## Placement

- Using the unit near power amplifiers (or other equipment containing large power transformers) may induce hum. To alleviate the problem, change the orientation of this unit; or move it farther away from the source of interference.
- This unit may interfere with radio and television reception. Do not use this unit in the vicinity of such receivers.
- Noise may be produced if wireless communications devices, such as cell phones, are operated in the vicinity of this unit. Such noise could occur when receiving or initiating a call, or while conversing. Should you experience such problems, you should relocate such wireless devices so they are at a greater distance from this unit, or switch them off.
- When moved from one location to another where the temperature and/or humidity is very different, water droplets (condensation) may form inside the unit. Damage or malfunction may result if you attempt to use the unit in this condition. Therefore, before using the unit, you must allow it to stand for several hours, until the condensation has completely evaporated.
- Depending on the material and temperature of the surface on which you place the unit, its rubber feet may discolor or mar the surface.
- Do not place containers or anything else containing liquid on top of this unit. Also, whenever any liquid has been spilled on the surface of this unit, be sure to promptly wipe it away using a soft, dry cloth.

## Repairs and Data

- Before requesting servicing, back up the data stored in the unit by writing down the stored information or by using V-1SDI RCS dedicated software (p. 31). Although we will do our utmost to preserve the data stored in your unit when we carry out repairs, in some cases, such as when the memory section is physically damaged, restoration of the stored content may be impossible. Roland assumes no liability concerning the restoration of any stored content that has been lost.

## Maintenance

- Never use benzine, thinners, alcohol or solvents of any kind, to avoid the possibility of discoloration and/or deformation.

## Grounding Terminal

- Depending on the circumstances of a particular setup, you may experience a discomforting sensation, or perceive that the surface feels gritty to the touch when you touch this device, microphones connected to it, or the metal portions of other objects, such as guitars. This is due to an infinitesimal electrical charge, which is absolutely harmless. However, if you are concerned about this, connect the ground terminal (see figure on page 9) with an external ground. When the unit is grounded, a slight hum may occur, depending on the particulars of your installation. If you are unsure of the connection method, contact the nearest Roland Service Center, or an authorized Roland distributor, as listed on the "Information."

### Unsuitable places for connection

- Water pipes (may result in shock or electrocution)
- Gas pipes (may result in fire or explosion)
- Telephone-line ground or lightning rod (may be dangerous in the event of lightning)

## Additional Precautions

- Any data stored within the unit can be lost as the result of equipment failure, incorrect operation, etc. To protect yourself against the irretrievable loss of important data stored in the unit, use V-1SDI RCS dedicated software (p. 31) to make backups.
- Roland assumes no liability concerning the restoration of any stored content that has been lost.
- Use a reasonable amount of care when using the unit's buttons, sliders, or other controls; and when using its jacks and connectors. Rough handling can lead to malfunctions.
- When disconnecting all cables, grasp the connector itself—never pull on the cable. This way you will avoid causing shorts, or damage to the cable's internal elements.
- To avoid disturbing others nearby, try to keep the unit's volume at reasonable levels.
- This unit allows you to switch images at high speed. For some people, viewing such images can cause headache, nausea, or other discomfort. Do not use this unit to create video that might cause these types of health problems. Roland Corporation will accept no responsibility for any such health problems that may occur in yourself or in viewers.
- Do not use connection cables that contain a built-in resistor.

# Panel Descriptions

## Top Panel/Front Panel

### [OUTPUT FADE] Knob p. 21, 26

This performs a fade-in or fade-out for the main output video, and adjusts the volume level for output audio.

- The indicators on the left and right of the [OUTPUT FADE] knob show the status of the fade.

Flashing	Fade-in/fade-out in progress
Dark	Normal output

### [FREEZE] Button p. 20, 21

- This stops (freezes) input video. The [FREEZE] button lights up during a freeze.
- It outputs a captured still image.
- It also outputs a still image transmitted from V-1SDI RCS dedicated software.

### [SETUP] Button p. 12

Pressing and holding the [SETUP] button (for 2 seconds or longer) to turn it on (lighted) displays the SETUP menu on the monitor connected to the MULTI-VIEW connector.

- SETUP Indicator**  
This lights up on operation of a button or knob for which panel lock (p. 30) is in effect.

### [AUDIO] Button p. 12, 26

Pressing and holding the [AUDIO] button (for 2 seconds or longer) to turn it on (lighted) displays the AUDIO menu on the monitor connected to the MULTI-VIEW connector.

- AUDIO Indicator**  
This indicates the audio input or output level.

### [MEMORY] Button p. 13

The memory function is turned on (lighted) while the [MEMORY] button is held depressed. You can save and recall up to eight types of settings, including video and audio settings and operation-panel states.

When the memory function is on, the [A-1] through [A-4] and [B-1] through [B-4] buttons function as memory selection buttons 1 through 8.

### [PinP] and [SPLIT] Buttons p. 22

These turn PinP, split, and other video compositing on and off. When turned on, the [PinP] or [SPLIT] button lights up.

### [CONTROL 1] and [CONTROL 2] Knobs p. 22

When the [PinP], [SPLIT], or [KEY LEVEL] button is on (lighted), these adjust the compositing effect.



### HDCP Indicator p. 17

This lights up, flashes, or goes dark according to HDCP (digital content protection) settings and the connection status of HDCP-compatible equipment.

**[KEY LEVEL] Button**

p. 25

When this is turned on (lighted), the [CONTROL 1] and [CONTROL 2] knobs function as shortcuts for adjusting the key level and key gain during DSK composition.

**A/B Fader**

p. 12, 18

This functions as a T-Bar video fader. This performs switching between the bus A (PGM) video and the bus B (PST) video.

- When a menu is displayed, this changes setting values.

**[DSK] (▲) Button**

p. 12, 24

This turns DSK composition on or off. When it is turned on, the [DSK] button lights up.

- When a menu is displayed, these select menu items.

**[AUTO] (▼) Button**

p. 12, 19

This automatically switches between the bus A video and the bus B video.

- When a menu is displayed, these select menu items.

**Cooling-fan Exhaust Port**



This expels internal heat to keep temperatures inside the V-1SDI cool.

**NOTE** Never obstruct the cooling-fan exhaust port. Obstructing the exhaust port might result in a temperature rise inside the V-1SDI and lead to malfunction due to heat.

**[WIPE], [MIX] (▲), and [CUT] (▼) Buttons**

p. 12, 18

These select video transition effects. The selected button lights up.

[WIPE]	The original video is broken into by the next video.
[MIX]	The two pictures are blended together as the video is switched.
[CUT]	The picture switches instantly.

- When a menu is displayed, the [MIX] (▲) and [CUT] (▼) buttons page through the menu.

**[A-1]–[A-4] Buttons**

p. 18

These select the video to input to bus A of the video mixer. The selected button lights up.

**[B-1]–[B-4] Buttons**

p. 18

These select the video to input to bus B of the video mixer. The selected button lights up.

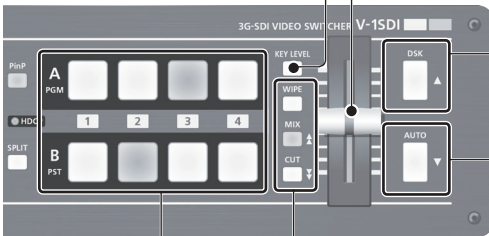

## Rear Panel (Connecting Your Equipment)

\* To prevent malfunction and equipment failure, always turn down the volume, and turn off all the units before making any connections.

\* Be sure to use cables and adaptor plugs with the proper connectors matching those of the other devices you are using.

### MULTI-VIEW Connector (\*1) p. 12, 16

This outputs the incoming video on channels 1 through 4 as a four-way split screen. Here you connect a monitor capable of HDMI input.



\* Menus are displayed on the connected monitor.

(\*1) You can also output different video (p. 16).

### PVW Connector (\*1) p. 16

This displays the video to be output next. Here you connect a monitor capable of SDI input.



### PGM Connector

This outputs the video mixing result (main output video). Here you connect a display or a video recorder or other recording device capable of SDI input.



### [POWER] Button p. 11

This turns the power on and off.

### DC IN Connector

This is for connecting the included AC adaptor.

Place the AC adaptor so the side with the indicator faces upwards and the side with printed information faces downwards. The indicator will light when you plug the AC adaptor into an AC outlet.

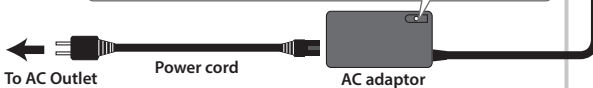

\* To prevent the inadvertent disruption of power to your unit (should the plug be pulled out accidentally), and to avoid applying undue stress to the jack, anchor the power cord using the cord hook, as shown in the illustration.

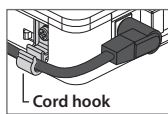

For information on how to attach the cord hook, refer to "Attaching the Power Cord Hook" (p. 10).

### USB Port p. 31



USB2.0 port

You use V-1SDI RCS dedicated software to operate the V-1SDI remotely from a connected computer.



\* The V-1SDI is designed to radiate heat from the entire rear panel. Accordingly, the rear panel might become hot during use, but this is not a malfunction.

**HDMI IN 4 Connector** p. 14, 15

Here you input the HDMI signal from a computer, a video camera, Blu-ray Disc player, or other video equipment.



**HDMI IN 3 Connector** p. 16

Here you input the HDMI signal from a video camera, Blu-ray Disc player, or other video equipment.

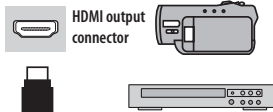

**SDI IN 1-3 Connectors** p. 16

Here you input SDI signals from video cameras, video recorders, and other video equipment.

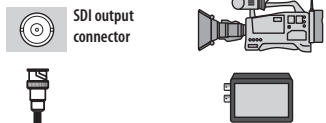

**Grounding Terminal**

You connect this to an external ground. For details, refer to "Grounding Terminal" in "IMPORTANT NOTES" (p. 5).

**AUDIO OUT Jacks**

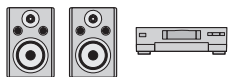

Audio input connectors

These output the results of the audio mix. Here you connect an audio recording deck, amplifier, speakers, or other such equipment. These accept RCA phono type plugs.

**AUDIO IN Jacks**

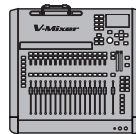

Audio output connectors

These are for incoming audio signals from an audio mixer, portable music players, or other audio or video equipment. These accept RCA phono type plugs.

## Side Panel (Connecting Your Equipment)

### MIC Jack

Here is where you connect a microphone. This accepts a miniature stereo phone plug. You can also use plug-in-power microphones.



### PHONES Jack

This is for connecting headphones. This accepts a miniature stereo phone plug.



### [MIC] Knob

This adjusts microphone input sensitivity.

### [PHONES] Knob

This adjusts the volume level for headphones.

### [FORMAT] Switch

p. 14

This switches the input/output format.

\* Before operating the [FORMAT] switch, be sure the power to the V-1SDI is turned off.

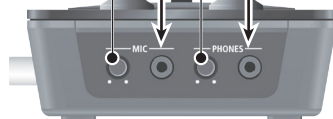
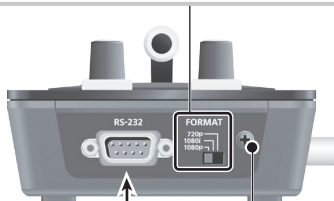

### RS-232 Connector

p. 31



Here you connect a device used to operate the V-1SDI by remote control (such as an RS-232-compatible computer).

### Attaching the Power Cord Hook

1. Detach the retainer screw indicated in the figure.

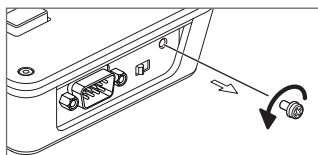

2. Using the screw you removed in step 1, secure the power-cord hook in place as shown in the figure.

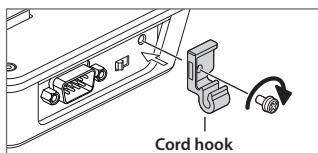

# Basic Operation

## Turning the Power On and Off

Once everything is properly connected (p. 8–10), be sure to follow the procedure below to turn on their power. If you turn on equipment in the wrong order, you risk causing malfunction or equipment failure.

- \* Before turning the unit on/off, always be sure to turn the volume down. Even with the volume turned down, you might hear some sound when switching the unit on/off. However, this is normal and does not indicate a malfunction.

### Turning the Power On

1. Make sure all devices are turned off.
2. Press the [POWER] button on the rear panel of the V-1SDI to turn on the power.



- \* This unit is equipped with a protection circuit. A brief interval (a few seconds) after turning the unit on is required before it will operate normally.

3. Turn on the power for the source devices.  
Turn on the power to video cameras or other source equipment connected to input connectors on the V-1SDI.
4. Turn on the power for the output devices.  
Turn on the power to projectors or other devices connected to output connectors on the V-1SDI.

### Turning the Power Off

1. Turn off the power in the sequence of first the output equipment, and then the sources.
2. Press the [POWER] button on the V-1SDI to turn off the power.

#### MEMO

- The power to the V-1SDI turns off automatically if a set interval elapses with no operation performed (Auto Off function).  
If you don't want the power to be turned off automatically, disengage the Auto Off function. For details, refer to "Turning Off the Power Automatically (Auto Off)" on this page.

## Turning Off the Power Automatically (Auto Off)

Auto Off is a feature that automatically turns off the power after no operation for a specific period of time. This helps prevent wasting electrical power. By factory default, the Auto Off function is set on. When the states described below persist for 240 minutes, the Auto Off function acts to automatically turn off the power.

- No operation performed on the V-1SDI
- No audio or video input

To turn the Auto Off function off or on, follow the steps below to change the setting.

#### MEMO

- When the power has been turned off by the Auto Off function, to restart, first press the [POWER] button to return it to the Off position, then turn on the power.

1. Display the SETUP menu (p. 12), then select "AUTO OFF."

```
[ SYSTEM ] (14/16)
HDCP           = OFF
FRAME RATE    = 59.94
FREEZE MODE   = ALL
DEINTERLACE MODE = BOB
AUTO OFF      = ON
OUTPUT FADE ASSIGN = V & A
```

2. Use the A/B fader to set the Auto Off function on or off.

Value	Explanation
ON	The Auto Off function is turned on. Power is turned off automatically.
OFF	The Auto Off function is turned off. Power is not turned off automatically.

3. Quit the menu (p. 12).

#### NOTE

- Any settings that you are in the process of editing will be lost when the power is turned off. If you have any settings that you want to keep, you should save them beforehand.

## Executing/Changing Specific Functions at Startup

You can execute or change the following functions at startup of the V-1SDI.

Operation at startup	Operation
Returning settings to the factory-default state at startup (p. 30)	Hold down the [DSK] and [AUTO] buttons and press the [POWER] button.
Setting "HDCP" on the SETUP menu to "ON" at startup (p. 17)	Hold down the [PinP] button and press the [POWER] button.
Setting "HDCP" on the SETUP menu to "OFF" at startup (p. 17)	Hold down the [SPLIT] button and press the [POWER] button.

### Using the Menus

This explains how to display menus and make settings for video and audio, and for the V-1SDI itself.

\* Menus are shown only on the monitor connected to the MULTI-VIEW connector (HDMI) (p. 8).

#### Displaying/Exiting Menus

The V-1SDI has three types of menus (SETUP, AUDIO, and INPUT STATUS).

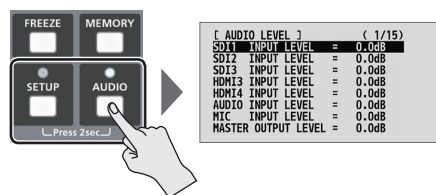

\* The button lights up during menu display.

#### SETUP Menu

You use this to make video-related settings and settings for the V-1SDI itself.

1. Press and hold the [SETUP] button (for 2 seconds or longer) to display the SETUP menu.
2. Press the [SETUP] or [AUDIO] button to quit the menu.

#### AUDIO Menu

You use this to make audio-related settings.

1. Press and hold the [AUDIO] button (for 2 seconds or longer) to display the AUDIO menu.
2. Press the [AUDIO] or [SETUP] button to quit the menu.

#### INPUT STATUS Menu

This shows the incoming video formats and the presence or absence of HDCP signals on the respective video channels.

1. Press and hold the [SETUP] and [AUDIO] button at the same time (for 2 seconds or longer) to display the INPUT STATUS menu.
2. Press the [SETUP] or [AUDIO] button to quit the menu.

#### Selecting Menu Items

1. Use the [MIX] (▲) and [CUT] (▼) buttons to change pages.

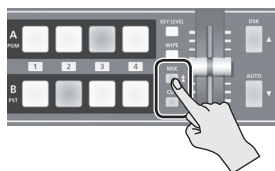

2. Use the [DSK] (▲) and [AUTO] (▼) buttons to move the cursor and select a menu item.

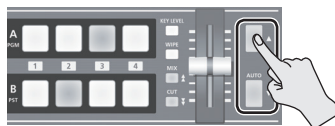

- Pressing and holding the [DSK] (▲) or [AUTO] (▼) button makes the cursor move rapidly.

#### Changing Setting Values

1. Use the A/B fader to change the setting value.

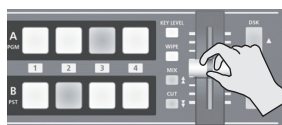

- \* For the following SETUP menu items, you apply the setting by pressing the [DSK] (▲) button. If 15 seconds elapse without applying the setting, the setting returns to its original value, with no change applied.

- VIDEO OUTPUT (3/16): COLOR SPACE
- VIDEO OUTPUT (3/16): DVI-D/HDMI SIGNAL
- SYSTEM (14/16): FRAME RATE

#### MEMO

- Pressing and holding the [WIPE] button (for 2 seconds) while a menu is displayed returns the currently selected menu item to its default value. Continuing to press and hold the [WIPE] button (for 5 seconds or longer) returns all menu items on the currently selected page to their default values.
- For detailed information on menu items, refer to the "Reference Manual" (PDF) available for download at the Roland website.

<https://proav.roland.com/>

## Saving/Recalling Settings (Memory)

You can take the current settings, including video and audio settings and the state of the operation panel, and save them as a single set in memory, for later recall and use when needed. The V-1SDI is provided with eight memories.

### Settings Saved in Memory

The following menu settings and operation-panel states are saved in the memories (1 through 8).

#### ① SETUP Menu Settings (Some)

The settings from VIDEO INPUT (page 1/16) to DSK (page 8/16) are saved.

#### ② AUDIO Menu Settings (All)

#### ③ State of the Operation Panel

State of the [OUTPUT FADE] knob

State of the [CONTROL 1] and [CONTROL 2] knobs

On/off status of the [PinP] and [SPLIT] buttons

[A-1] through [A-4] button selection

[B-1] through [B-4] button selection

On/off status of the [KEY LEVEL] button

[MIX], [WIPE], and [CUT] button selection

On/off status of the [DSK] button

State of the A/B fader

#### MEMO

- The SETUP menu settings from PANEL (page 9/16) through SYSTEM (page 16/16) are not saved in memory. Only a single set is saved in the unit. After settings have been changed, they are saved in the unit when you exit the menu.
- You can recall settings at a specified memory number at startup. To specify the memory number you want to recall, go to the SETUP menu, and at MEMORY (page 13/16), use "POWER ON LOAD."
- By factory default, the state of the operation panel is updated to the state saved in memory when you recall a memory. To keep the state of the operation panel from being updated, go to the SETUP menu, and at MEMORY (page 13/16), set "MEMORY PANEL LOAD" to "OFF."

### Saving/Recalling

The memory function is turned on while the [MEMORY] button is held depressed.

At this time the [A-1] through [A-4] and [B-1] through [B-4] buttons function as memory selection buttons 1 through 8.

The currently selected button lights up in blue.

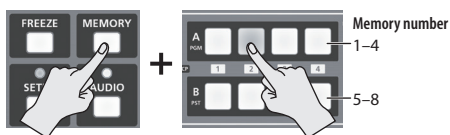

#### Memory 1 functions as a Last Memory.

By factory default, memory 1 functions as a Last Memory. Settings are automatically saved in memory 1 when you exit the menu or release the [MEMORY] button.

To stop using the Last Memory function, go to the SETUP menu, and at MEMORY (page 13/16), set "AUTO MEMORY" to "OFF."

#### Saving

##### NOTE

- When memory 1 has been selected as a destination for saving, the values saved there might be overwritten by the Last Memory function.

1. Hold down the [MEMORY] button and press and hold (for 2 seconds or longer) the button from [A-1] through [A-4] and [B-1] through [B-4] for the number where you want to save the settings. The [A-1] through [A-4] and [B-1] through [B-4] buttons all briefly light up in blue, and the current settings are saved.
2. To turn off the memory function, release the [MEMORY] button.

#### Recalling

1. Hold down the [MEMORY] button and press the button from [A-1] through [A-4] and [B-1] through [B-4] for the number where you want to recall the settings. The settings are recalled. The currently selected button lights up in blue.
2. To turn off the memory function, release the [MEMORY] button.

# Video Input/Output Settings

## Setting the Video Input/Output Format

You set the input/output format to match the incoming video signal.

1. Slide the [FORMAT] switch on the side panel to set the input/output format.

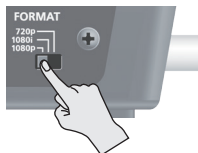

[FORMAT] switch	Input formats (*1)	Output format
1080p	1080p, 1080i	1080p
1080i	1080p, 1080i	1080i
720p	720p	720p

(\*1) This sets the input format for channels 1 through 3. For information on the input format for channel 4, refer to the column below.

### NOTE

- Before operating the [FORMAT] switch, be sure the power to the V-1SDI is turned off.

### Input Format of Channel 4 (HDMI IN 4)

Channel 4 (HDMI IN 4) supports the following input formats.

Input formats			
480/59.94i	576/50i	480/59.94p	576/50p
720/59.94p	720/50p	1080/59.94i	1080/50i
1080/59.94p	1080/50p	VGA (640 x 480/60 Hz)	
SVGA (800 x 600/60 Hz)		XGA (1024 x 768/60 Hz)	
WXGA (1280 x 768/60 Hz)			
SXGA (1280 x 1024/60 Hz)			
FWXGA (1366 x 768/60 Hz)			
SXGA+ (1400 x 1050/60 Hz)			
UXGA (1600 x 1200/60 Hz)			
WUXGA (1920 x 1200/60 Hz)			

By factory default, the EDID assignment for channel 4 is "AUTO" (set so that EDID values of all inputtable formats are sent).

If you want to specify the EDID value that is sent, go to the SETUP menu, and at VIDEO INPUT (page 2/16), change the "EDID" setting.

## Internal Processing

The V-1SDI's internal processing is progressive. Interlaced input video is automatically converted to a progressive signal.

The picture might appear jagged at this time, or the picture in a PinP inset screen or preview four-way split screen might waver. This is due to progressive conversion, and is not a malfunction.

### MEMO

- The methods for converting an interlaced signal to a progressive signal are of two types: "BOB" and "WEAVE."

BOB	This interpolates the top field and bottom field, and unites them in a single frame. This is optimal for video that contains much movement.
WEAVE	This joins the top field and bottom field in a single frame. This is optimal for video that contains little movement.

To set the conversion method, go to the SETUP menu, and at SYSTEM (page 14/16), use "DEINTERLACE MODE" to make the setting.

## About Frame Rates

Frame rates that can be input are "59.94" and "50." Inputting video at a frame rate other than these might result in no output or dropped frames.

To change the frame rate, go to the SETUP menu, and at SYSTEM (page 14/16), set "FRAME RATE" to "59.94" or "50," then press the [DSK] (▲) button.

### MEMO

- When you have changed the frame rate, turn to the power to the V-1SDI off and back on.

## Adjusting Output Video

You can adjust the output video to match the equipment receiving the output from the V-1SDI.

### MEMO

- You can output a color bar, useful for adjusting the image quality of a display. Go to the SETUP menu, and at SYSTEM (page 16/16), set "COLOR BAR OUTPUT" to "ON."

### 1. Display the SETUP menu (p. 12), then select a menu item.

[ VIDEO OUTPUT ]	( 3/16 )
SDI OUTPUT	
PWM ASSIGN	= PST
3G-SDI MAPPING	= LEVEL B
HDMI OUTPUT	
OUTPUT ASSIGN	= PST
COLOR SPACE	= AUTO
DVI-D/HDMI SIGNAL	= AUTO

You use the following menu items to adjust the output video.

VIDEO OUTPUT (page 3/16)	
Menu item	Explanation
3G-SDI MAPPING	This sets the mapping structure for 3G-SDI output.
COLOR SPACE	This sets the color space for HDMI output.
DVI-D/HDMI	This sets the output mode for HDMI output.

VIDEO OUTPUT (page 4/16)	
Menu item	Explanation
CONTRAST (*2)	This adjusts the contrast.
SATURATION (*2)	This adjusts the saturation.
BRIGHTNESS (*2)	This adjusts the brightness.

(\*2) These settings are shared by HDMI output (the MULTI-VIEW connector) and SDI output (the PGM and PVW connectors).

### 2. Use the A/B fader to adjust the output video.

\* The settings for the following menu items are applied by pressing the [DSK] (▲) button. If 15 seconds elapse without applying the setting, the setting returns to its original value, with no change applied.

- VIDEO OUTPUT (3/16): COLOR SPACE
- VIDEO OUTPUT (3/16): DVI-D/HDMI SIGNAL

### 3. Quit the menu (p. 12).

## Adjusting HDMI Input Video on Channel 4

You can adjust image quality and set the EDID value for video input via HDMI IN 4.

### 1. Display the SETUP menu (p. 12), then select a menu item.

[ VIDEO INPUT ]	( 1/16 )
CH3 INPUT SELECT	= AUTO
CH4 HDMI	
SCALING TYPE	= FULL
H. POSITION	= 0
V. POSITION	= 0
ZOOM	= 100

You use the following menu items to adjust HDMI input video on channel 4.

VIDEO INPUT (page 1/16-2/16)	
Menu item	Explanation
SCALING TYPE	This sets the scaling type.
H. POSITION	This adjusts the display position in the horizontal direction.
V. POSITION	This adjusts the display position in the vertical direction.
ZOOM	This adjusts the zoom ratio.
CONTRAST	This adjusts the contrast.
SATURATION	This adjusts the saturation.
BRIGHTNESS	This adjusts the brightness.
FLICKER FILTER	This reduces flicker.
EDID	This sets the EDID value.

### 2. Use the A/B fader to adjust the HDMI input video.

### 3. Quit the menu (p. 12).

## Assigning a Video Source to Channel 3

By factory default, the selection of SDI input or HDMI input for channel 3 is set to "AUTO" (automatic detection of the connection). When devices are connected to both the SDI IN 3 connector and the HDMI IN 3 connector, SDI input takes precedence.

When you want to input video via a specified connector, change this setting.

1. Display the SETUP menu (p. 12), then select "CH3 INPUT SELECT."

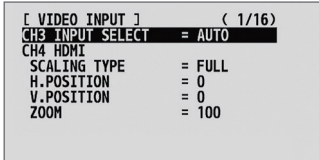

2. Use the A/B fader to specify the video source to input on channel 3.

Value	Explanation
AUTO	The connector where the connection is made is automatically detected and video is output. When devices are connected to both the SDI IN 3 connector and the HDMI IN 3 connector, SDI input takes precedence.
SDI	Video is input only via the SDI IN 3 connector.
HDMI	Video is input only via the HDMI IN 3 connector.

3. Quit the menu (p. 12).

## Switching the View Mode of Preview Output

Three types of view modes are available for the V-1SDI's preview output. You can set the view mode individually for the PVW connector (SDI) and the MULTI-VIEW connector (HDMI).

1. Display the SETUP menu (p. 12), then select "PVW ASSIGN" (PVW connector) or "OUTPUT ASSIGN" (MULTI-VIEW connector).

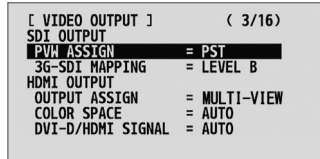

2. Use the A/B fader to set the view mode.

Value	Explanation																					
	This displays the incoming video on channels 1 through 4 as a four-way split screen.																					
	<p style="text-align: center;">└─ Audio level meter</p>																					
MULTI-VIEW	The video is displayed with a colored border that is interlinked with the selected [A-1] through [A-4] or [B-1] through [B-4] button. Red border: Video currently being output Green border: Video to be output next																					
	<b>Displaying the audio level meter</b>																					
	* This is displayed at the bottom of the screen only for output from the MULTI-VIEW connector (HDMI).																					
	<table border="1"> <thead> <tr> <th>Indication</th> <th>Input/output name</th> <th>Level</th> </tr> </thead> <tbody> <tr> <td>IN1</td> <td>SDI IN 1</td> <td rowspan="4">                     (dB)                       0 — Red                       -6 —                       -10 — Yellow                       -20 —                       -30 — Green                       -40 —                       -50 —                 </td> </tr> <tr> <td>IN2</td> <td>SDI IN 2</td> </tr> <tr> <td>IN3</td> <td>SDI IN 3 or HDMI IN 3</td> </tr> <tr> <td>IN4</td> <td>HDMI IN 4</td> </tr> <tr> <td>AUD</td> <td>AUDIO IN</td> <td></td> </tr> <tr> <td>MIC</td> <td>MIC</td> <td></td> </tr> <tr> <td>OUT</td> <td>MASTER OUT</td> <td></td> </tr> </tbody> </table>	Indication	Input/output name	Level	IN1	SDI IN 1	(dB) 0 — Red -6 — -10 — Yellow -20 — -30 — Green -40 — -50 —	IN2	SDI IN 2	IN3	SDI IN 3 or HDMI IN 3	IN4	HDMI IN 4	AUD	AUDIO IN		MIC	MIC		OUT	MASTER OUT	
Indication	Input/output name	Level																				
IN1	SDI IN 1	(dB) 0 — Red -6 — -10 — Yellow -20 — -30 — Green -40 — -50 —																				
IN2	SDI IN 2																					
IN3	SDI IN 3 or HDMI IN 3																					
IN4	HDMI IN 4																					
AUD	AUDIO IN																					
MIC	MIC																					
OUT	MASTER OUT																					
PGM	This displays the video currently being output.																					
PST	This displays the video to be output next.																					

\* Labels for identifying SDI and HDMI in all view modes are displayed only for output from the MULTI-VIEW connector (HDMI).

3. Quit the menu (p. 12).



## Inputting Copyright-protected (HDCP) Video

To input copyright-protected (HDCP) video from a Blu-ray Disc player or the like, you make the setting for enabling HDCP input.

\* The V-1SDI must be connected to an HDCP compatible display for HDCP protected video to be connected.

1. Display the SETUP menu (p. 12), then select "HDCP."

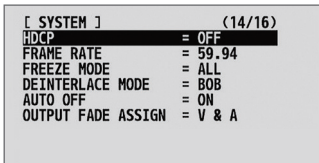

2. Use the A/B fader to set this to "ON."

Value	Explanation
ON	Copyright-protected (HDCP) video can be input. HDCP is also added to the video that is output.
OFF	Copyright-protected (HDCP) video cannot be input.

3. Quit the menu (p. 12).

## Output from Connectors

When "HDCP" is set to "ON," video is output only from the MULTI-VIEW connector (HDMI). No video is output from the PVW connector (SDI) or PGM connector (SDI).

## Operation of the HDCP indicator

The HDCP indicator on the top panel operates as follows, regardless of input.



Indicator	"HDCP" setting	Connection status
Lighted	ON	An HDCP-compatible device is connected to the MULTI-VIEW connector.
Flashing	ON	No HDCP-compatible device is connected to the MULTI-VIEW connector. Alternatively, a device that does not support HDCP is connected.
Dark	OFF	—

# Video Operations

## Switching the Video

You can switch the video input to bus A and to bus B of the video mixer.

### About the Operation Mode for Video Transitions

Two operation modes are available for video transitions made using the A/B fader: the “A/B mode” and the “PGM/PST mode.”

#### PGM/PST Mode

The video at the PGM (bus A) position is always output, and for PST (the bus B) position, these select the video to be output next.

Operating the A/B fader causes the selected video at the PST position to be output from the PGM position.

#### A/B Mode

The video on the bus toward which the A/B fader is flipped is output.

By factory default, the operation mode is set to the PGM/PST mode.

When you want to work in the A/B mode, go to the SETUP menu, and at PANEL (page 9/16), set “PANEL MODE” to “A/B.”

#### MEMO

- You can change the color in which the [A-1] through [A-4] and [B-1] through [B-4] buttons light up. Go to the SETUP menu, and at PANEL (page 9/16), use “PGM LED” (buttons for current video output) or “PST LED” (buttons for next video output) to make the setting.

### Switching Using the PGM/PST Mode

Video at the PGM position is always output. At the PST position you select the video you want to output next (standby), then switch the video.

1. Move the A/B fader all the way to one end or the other.

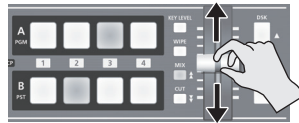

2. Press the [WIPE], [MIX], or [CUT] button to select a transition effect.



The selected button lights up.

#### MEMO

- You can change the transition pattern used for a wipe or mix transition. Go to the SETUP menu, and at TRANSITION/PinP (page 5/16), use “WIPE” or “MIX” to make the setting.  
For a list of transition-pattern types, refer to “Transition Effects List” (p. 33).

3. Press one of the [B-1] through [B-4] buttons to select the video you want to show next.

Lighted in red: Video currently being output (PGM)  
Lighted in green: Video to be output next (PST)  
Lighted in white: Channel with video input

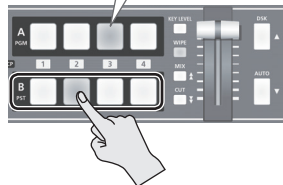

4. Move the A/B fader in the direction opposite to the direction in step 1.

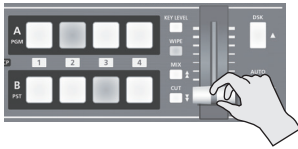

The output video is switched.

When the video has been switched completely, the lighted buttons for the PGM position and PST position change places.

**MEMO**

- Directly selecting the video channel at the PGM position of the video currently being output switches the video with a cut, regardless of any selection of a transition effect.

### Using the [AUTO] Button to Switch Video Automatically

You can use the [AUTO] button to switch video automatically, without using the A/B fader.

**MEMO**

- You can perform operations using the [AUTO] button both in the PGM/PST mode and in the A/B mode.

1. Press the [AUTO] button at the desired timing for switching the video.

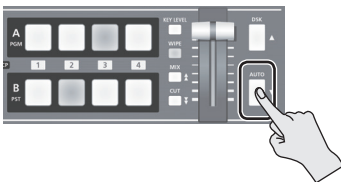

The video at the PGM (bus A) position and the PST (bus B) position is switched with every press of the [AUTO] button.

- \* When a mix or wipe has been selected as the transition effect, the value set for "TRANSITION TIME" at TRANSITION/PinP (page 5/16) on the SETUP menu is used for the video transition time.

**MEMO**

- When you use the [AUTO] button to switch video, the actual output might come to differ from the position of the A/B fader.

Operating the A/B fader while in this state yields no change in output until the position of the A/B fader matches the actual output.

- You can make the [AUTO] button dark. Go to the SETUP menu, and at PANEL (page 9/16), set "AUTO LED" to "OFF."

### Switching in the A/B Mode

The video on the bus toward which the A/B fader is flipped is output.

1. Use the [A-1] through [A-4] and [B-1] through [B-4] buttons to select the video to input on bus A and bus B.

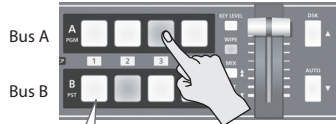

- Lighted in red: Video currently being output
- Lighted in green: Video to be output next
- Lighted in white: Channel with video input

2. Press the [WIPE], [MIX], or [CUT] button to select a transition effect.

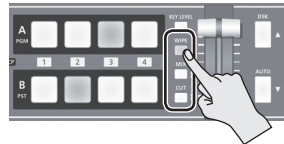

The selected button lights up.

**MEMO**

- You can change the transition pattern used for a wipe or mix transition. Go to the SETUP menu, and at TRANSITION/PinP (page 5/16), use "WIPE" or "MIX" to make the setting. For a list of transition-pattern types, refer to "Transition Effects List" (p. 33).

3. Move the A/B fader to the bus A position or the bus B position.

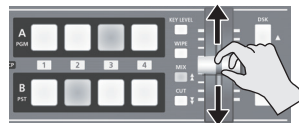

The output video is switched.

**MEMO**

- Directly selecting the video channel at the bus position of the video currently being output switches the video with a cut, regardless of any selection of a transition effect.

## Switching Automatically (Auto Scan)

The video on channels 1 through 4 is switched automatically in sequence.

**MEMO**

- Any channels carrying no video input are skipped.

- Display the SETUP menu (p. 12), then select "AUTO SCAN."

[ SYSTEM ]	(15/16)
PWM INDICATOR	= OFF
LABEL	= ON
TALLY	= ON
AUDIO LEVEL METER	= LOWER
<b>AUTO SCAN</b>	= <b>OFF</b>
SCAN TIME	= 5sec
TRANS TIME	= 0.5sec

- Use the A/B fader to set this to "ON."

Value	Explanation
ON	Video automatic switching is turned on. The video on channels 1 through 4 is switched automatically.
OFF	The video automatic switching feature is turned off.

- You can use the following SETUP menu items to set the interval for video display and the time applies to the video transition.

SYSTEM (page 15/16)	
Menu item	Explanation
SCAN TIME	This sets the display interval for video within a range of 1 to 120 seconds.
TRANS TIME	This sets the time the video transition takes, within a range of 0.0 to 4.0 seconds. * These are effective when a mix or wipe is selected as the transition effect.

\* If the time that the video transition takes is longer than the video display interval, the time interval for the video transition takes precedence.

- Quit the menu (p. 12).

## Freezing Input Video (Freeze)

This temporarily pauses the incoming video.

You can apply transition effects and perform video compositing during a video freeze.

### Setting the Freeze Mode

Two operation modes are available for freezes: the "ALL mode" and the "SELECT mode."

By factory default, this is set to "ALL" (freeze all incoming video).

If you want to select the input video to freeze, go to the SETUP menu, and at SYSTEM (page 14/16), set "FREEZE MODE" to "SELECT."

**MEMO**

- When the "FREEZE MODE" is set to "STILL," the [FREEZE] button functions as a still-image output button.

For more information, refer to "Outputting a Still Image" (p. 21).

### Freezing Input Video

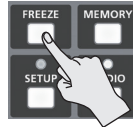

#### When the Freeze Mode Is Set to "ALL"

- Press the [FREEZE] button to turn on freeze (lighted).  
All video that is input freezes.
- To turn off freeze, press the [FREEZE] button a second time.

#### When the Freeze Mode Is Set to "SELECT"

- Press the [FREEZE] button to turn on freeze (lighted).  
The [A-1] through [A-4] buttons all flash in red.
- Press one of the [A-1] through [A-4] buttons to select the incoming video you want to freeze.



The selected input video freezes.

- To turn off freeze, press the [FREEZE] button a second time.

## Applying a Fade to the Main Output Video (Output Fade)

You can apply a fade to the V-1SDI's main output video.

This lets you make the main output video fade to a black (or white) picture at times when you want to suppress video output, such as during intervals in a presentation, event or band performance.

### Functioning of the [OUTPUT FADE] Knob

You can assign the following functions to the [OUTPUT FADE] knob.

- Applying a fade to the main output video
- Adjusting the volume level of output audio

To specify the function of the [OUTPUT FADE] knob, go to the SETUP menu, and at SYSTEM (page 14/16), use "OUTPUT FADER ASSIGN" to make the setting.

\* By factory default, this is set to "V & A."

Value	Function of the [OUTPUT FADE] knob
VIDEO	Applies a fade to the main output video.
V & A	Simultaneously applies a fade to the main output video and adjusts the volume level of output audio.
AUDIO	Adjusts the volume level of output audio (p. 26).
BLACK / A	Turning counterclockwise applies a black fade to the main output video. Turning clockwise adjusts the volume level of output audio.

### Applying a Fade-out

1. Turn the [OUTPUT FADE] knob all the way clockwise or counterclockwise.



\* When set to "BLACK / A," only counterclockwise turning (black fade) has any effect.

Turning the [OUTPUT FADE] knob clockwise performs a fade-out to white, and turning the knob counterclockwise performs a fade-out to black.

Applying a fade makes the indicators to the left or right of the knob flash.

### Applying a Fade-in

1. Return the [OUTPUT FADE] knob to its center position.

The indicator stops flashing and lights up steadily, and output starts.

## Capturing a Still Image from Input Video

You can capture still images from input video on channel 4. You can output captured still images from the PGM connector (SDI), or use them as a source for DSK compositing (p. 24).

\* You can also use V-1SDI RCS dedicated software to send still images from a computer to the V-1SDI.

### Capturing a Still Image

#### NOTE

- Either the captured still image or the still image sent from V-1SDI RCS is temporarily stored in the unit. If a new still image is captured or is sent from V-1SDI RCS while a still image is already saved, the previously saved still image is overwritten. Also, still-image data is deleted when the power is turned off.

1. Input video on channel 4.
2. Display the SETUP menu (p. 12), then select "CAPTURE IMAGE."

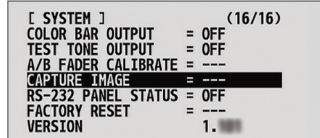

3. Move the A/B fader to the bus A position.
4. Make sure the message "PRESS "UP"" is displayed, and press the [DSK] (▲) button. Capturing is carried out, and the message "COMPLETE" is displayed.
5. Quit the menu (p. 12).

### Outputting a Still Image

1. Change the functioning of the [FREEZE] button. Go to the SETUP menu, and at SYSTEM (page 14/16), set "FREEZE MODE" to "STILL". This makes the [FREEZE] button function as a still-image output button.
2. Press the [FREEZE] button.

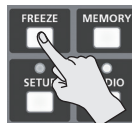

\* When you output a still image, the change is made using a cut, regardless of the transition-effect selection. All output goes dark momentarily during the change, but this is not a malfunction.

The still image is output from the PGM connector.

3. To return from still-image output to video output, press the [FREEZE] button once more.

# Video Composition Operations

You can composite video on bus A and video on bus B. The V-1SDI has seven built-in types of composition.

## Selecting a Composition Type

This selects the composition type to assign to the [PinP] or [SPLIT] button.

1. Display the SETUP menu (p. 12), then select "PinP" or "SPLIT."

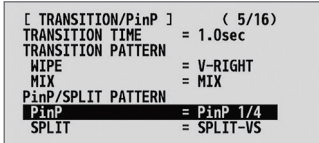

2. Use the A/B fader to select the compositing effect to assign to the [PinP] or [SPLIT] button.

Value	Explanation	
PinP 1/4	This composites video in an inset screen onto a background video. The horizontal size of the inset screen is 1/4 the width of the background video.	
PinP 1/3	This composites video in an inset screen onto a background video. The horizontal size of the inset screen is 1/3 the width of the background video.	
PinP 1/2	This composites video in an inset screen onto a background video. The horizontal size of the inset screen is 1/2 the width of the background video.	
SPLIT-VS	This composites the video stretched vertically.	
SPLIT-VC	This composites the video with its center section vertically cropped.	
SPLIT-HS	This composites the video stretched horizontally.	
SPLIT-HC	This composites the video with its center section horizontally cropped.	
QUAD	This composites the input video on channels 1 through 4 into one screen.	

3. Quit the menu (p. 12).

### MEMO

- You can change the composition type of the [PinP] button by holding down the [PinP] button and turning the [CONTROL 1] knob. For the [SPLIT] button, you can change the type by holding down the [SPLIT] button and turning the [CONTROL 2] knob.

## Compositing Four Video Pictures into One Screen

This composites the input video on channels 1 through 4 into one screen.



### MEMO

- Performing a video transition while video compositing is in progress is not possible.

1. Follow the procedure in "Selecting a Composition Type" on this page to select "QUAD."
2. Press the [PinP] or [SPLIT] button to turn on video compositing (making the button light up).



The input video on channels 1 through 4 is composited into one screen.

3. To turn off video compositing, press the [PinP] or [SPLIT] button a second time.

## Compositing Using Picture-in-Picture

This composites video in an inset screen onto a different background video. This section describes operations when in the PGM/PST mode (p. 18).

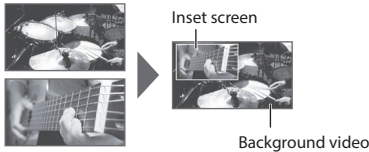

1. Follow the procedure in “Selecting a Composition Type” (p. 22) to select “PinP 1/4,” “PinP 1/3,” or “PinP 1/2.”
2. Use the [A-1] through [A-4] buttons to separately select the video you want to use as the background video.

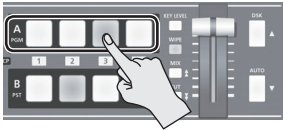

3. Use the [B-1] through [B-4] buttons to separately select the video you want to use as the inset screen.

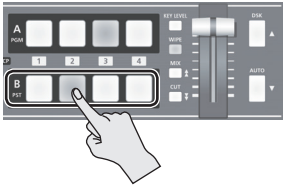

4. Press the [PinP] or [SPLIT] button to turn on video compositing (making the button light up).



5. Use Preview to check the position and size of the inset screen.

Setting the view mode for preview output to “PST” displays the inset screen in Preview (against a black background), allowing you to check the position and size of the inset screen.

For details about output modes, refer to “Switching the View Mode of Preview Output” (p. 16).

6. Turn the [CONTROL 1] and [CONTROL 2] knobs to adjust the display position of the inset screen.



[CONTROL 1] knob

This adjusts the inset screen's display position horizontally.

[CONTROL 2] knob

This adjusts the inset screen's display position vertically.

7. Press the [AUTO] button.



The inset screen is composited onto the background video and the result is output. Pressing the [AUTO] button a second time makes the inset screen disappear.

\* You can also display or hide the inset screen by operating the A/B fader.

8. To turn off video compositing, press the [PinP] or [SPLIT] button a second time.

### MEMO

- You can change the width and color of the border added to the inset screen. Go to the SETUP menu, and at TRANSITION/PinP (page 6/16), make the settings for “WIDTH” and “COLOR.”

## Compositing Using Split

This composites two video streams in a split screen. The video at the PGM (video currently being output) is displayed above or on the left, and the video at the PST (video to be output next) is displayed below or on the right.

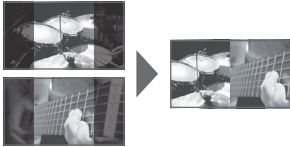

**MEMO**

- While compositing of the video is in progress, the video switches with cuts regardless of the selected transition effect.

1. Follow the procedure in "Selecting a Composition Type" (p. 22) to select "SPLIT-VS," "SPLIT-VC," "SPLIT-HS," or "SPLIT-HC."
2. Press one of the [A-1] through [A-4] buttons to select the video you want to display above or on the left.
3. Press one of the [B-1] through [B-4] buttons to select the video you want to display below or on the right.
4. Press the [SPLIT] or [PinP] button to turn on video compositing (making the button light up).



The video you selected in steps 2 and 3 is composited.

5. Turn the [CONTROL 1] and [CONTROL 2] knobs to adjust the display position for the video.

\* You can adjust this when you selected "SPLIT-HC" or "SPLIT-VC" in step 1.

● **When Set to SPLIT-HC**

This adjusts the vertical position of the video displayed above or below.

[CONTROL 1] knob: Upper video  
[CONTROL 2] knob: Lower video

● **When Set to SPLIT-VC**

This adjusts the horizontal position of the video displayed on the left or right.

[CONTROL 1] knob: Video on the left  
[CONTROL 2] knob: Video on the right



6. To turn off video compositing, press the [SPLIT] or [PinP] button a second time.

## Compositing Using DSK

This takes video composited upstream using PinP or the like, and performs further downstream compositing with text or images.

Using DSK (downstream keying), you can switch the background video while text or images remain displayed.

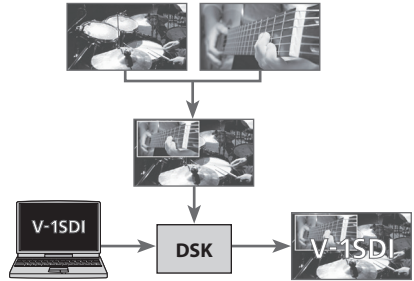

## Setting the Extraction Color

By factory default, the extraction color for DSK is set to "BLU-C.KEY" (blue).

If you want to use white, black, or green as the extraction color, then change the setting.

1. Display the SETUP menu (p. 12), then select "KEY TYPE."

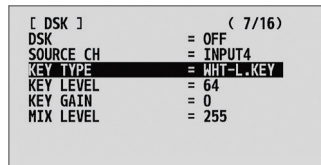

2. Use the A/B fader to specify the extraction color to use when compositing.

Value	Explanation
WHT-L.KEY	This uses a brightness threshold to make white transparent.
BLK-L.KEY	This uses a brightness threshold to make black transparent.
GRN-C.KEY	This uses a color threshold to make green transparent.
BLU-C.KEY	This uses a color threshold to make blue transparent.

3. Quit the menu (p. 12).



## Compositing Using DSK

### 1. Input a logo or image.

By factory default, text and images input via "INPUT 4" (input channel 4) are set to undergo DSK composition.

If you want to use text or images input via a different channel, go to the SETUP menu, and at DSK (page 7/16), use "SOURCE CH" to change the input channel.

If you want to perform compositing using a captured still image (p. 21) or a still image sent from V-1SDI RCS dedicated software, change the setting to "STILL."

### 2. Output the background video.

### 3. Press the [DSK] button to turn on DSK (making the button light up).

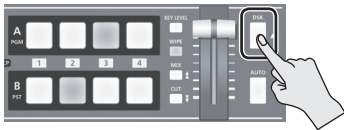

The text or image is composited and the results are output.

### 4. Press the [KEY LEVEL] button.

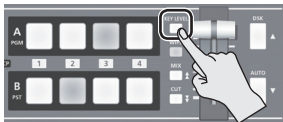

The [KEY LEVEL] button lights up, and you can now use the [CONTROL 1] and [CONTROL 2] knobs to adjust key level and key gain.

### 5. Turn the [CONTROL 1] or [CONTROL 2] knob to adjust the degree of effect applied.



**[CONTROL 1] knob**  
This adjusts the degree of extraction (key level) for the text and images.

**[CONTROL 2] knob**  
This adjusts the degree of blur for the edges (key gain) for the text and images.

### 6. After finishing adjusting key level and key gain, press the [KEY LEVEL] button a second time.

The [KEY LEVEL] button goes dark.

### 7. To turn off DSK, press the [DSK] button a second time.

The [DSK] button goes dark and the text and images disappear from the output.

#### MEMO

- You can adjust the overall density of the text and images being composited using DSK. Go to the SETUP menu, and at DSK (page 7/16), adjust the value of "MIX LEVEL."
- For the fade time used for text and images composited using DSK, the value of "TRANSITION TIME" at TRANSITION/PinP (page 5/16) on the SETUP menu is applied.
- When the extraction color is "GRN-C.KEY" (green) or "BLU-C.KEY" (blue), you can use the following SETUP menu items to fine-tune hue and saturation.

DSK (page 8/16)	
Menu item	Explanation
HUE WIDTH	This adjusts the hue width (range).
HUE FINE	This adjusts the center position for hue.
SATURATION WIDTH	This adjusts the saturation width (range).
SATURATION FINE	This adjusts the center position for saturation.

- You can make the [DSK] button dark. Go to the SETUP menu, and at PANEL (page 9/16), set "DSK LED" to "OFF"

# Audio Operations

## Adjusting the Volume Level

This adjusts the volume level of input audio and output audio.

1. Display the AUDIO menu (p. 12), then select the input audio whose volume level you want to adjust.

[ AUDIO LEVEL ]	( 1/15 )
SDI1 INPUT LEVEL	= 0.0dB
SDI2 INPUT LEVEL	= 0.0dB
SDI3 INPUT LEVEL	= 0.0dB
HDMI3 INPUT LEVEL	= 0.0dB
HDMI4 INPUT LEVEL	= 0.0dB
AUDIO INPUT LEVEL	= 0.0dB
MIC INPUT LEVEL	= 0.0dB
MASTER OUTPUT LEVEL	= 0.0dB

You use the following menu items to adjust the volume level of input audio.

AUDIO LEVEL (page 1/15)	
Menu item	Explanation
SDI 1-3 INPUT LEVEL	Input audio from respective SDI IN sources
HDMI 3, 4 INPUT LEVEL	Input audio from respective HDMI IN sources
AUDIO INPUT LEVEL	Input audio from AUDIO IN
MIC INPUT LEVEL	Input audio from MIC

2. Use the A/B fader to adjust the volume level for the respective input audio.

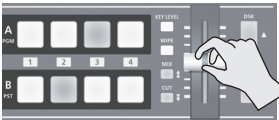

Raise the volume level of audio you want to make more prominent, such as a microphone, and lower the volume level for other audio.

When no audio is input, and for audio that is unused, set the volume level to “-INF.”

### MEMO

- Setting “MASTER OUTPUT LEVEL” to “-INF” results in no audio output from the output connectors.
- To adjust MIC input sensitivity, you use the [MIC] knob on the side panel.

3. Select “MASTER OUTPUT LEVEL.”

[ AUDIO LEVEL ]	( 1/15 )
SDI1 INPUT LEVEL	= 0.0dB
SDI2 INPUT LEVEL	= 0.0dB
SDI3 INPUT LEVEL	= 0.0dB
HDMI3 INPUT LEVEL	= 0.0dB
HDMI4 INPUT LEVEL	= 0.0dB
AUDIO INPUT LEVEL	= 0.0dB
MIC INPUT LEVEL	= 0.0dB
MASTER OUTPUT LEVEL	= 0.0dB

4. Use the A/B fader to adjust the volume level of output audio.
5. Quit the menu (p. 12).

### MEMO

- You can also use the [OUTPUT FADE] knob to adjust the volume level of output audio. For details, refer to “Functioning of the [OUTPUT FADE] Knob” (p. 21).

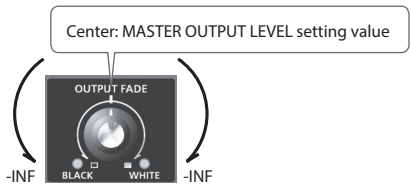

- You can output a test tone, which is useful for adjusting the volume level. Go to the SETUP menu, and at SYSTEM (page 16/16), set “TEST TONE OUTPUT” to “-20dB@1kHz,” “-6 dB@1kHz,” or “0dB@1kHz.”
- You can check the AUDIO indicator or the level meter (p. 16) to determine whether the volume has been adjusted to a suitable level.

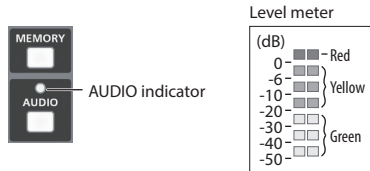

Indicator	Status
Red	This lights up at 0 dB or higher. It indicates an excessive volume level.
Yellow	This lights up at -19 to -1 dB. It indicates an appropriate volume level.
Green	This lights up at -50 to -20 dB. It indicates a too-low volume level.

\* By factory default, the display of the AUDIO indicator is set to “MASTER OUT” (output audio signal level).

If you want to use the AUDIO indicator to monitor other audio signal, go to the SETUP menu, and at PANEL (page 8/15), make the setting using “AUDIO LED.”

\* If the volume level of speaker output is unsuitable even when the volume level on the V-1SDI has been adjusted so that the AUDIO indicator and level meter light up in yellow, adjust the volume for the speakers and amplifiers. Using “MASTER OUTPUT LEVEL” to make adjustments can sometimes result in distortion or poorer sound quality.

# Applying Effects to Audio

You can apply effects to audio that is input and output to adjust its sound quality.

## Applying Effects to Input Audio

This applies effects and adjusts sound quality for audio input via AUDIO IN, MIC, SDI IN, and HDMI IN. The following table shows the effects you can use with the different input audio streams.

Input audio	Effects				
	EQ	DELAY	GATE	COMP	HPF
AUDIO IN	✓	✓	—	—	—
MIC	✓	✓	✓	✓	✓
SDI IN	✓	✓	—	—	—
HDMI IN	✓	✓	—	—	—

1. Display the AUDIO menu (p. 12), then select the effect menu item you want to use.

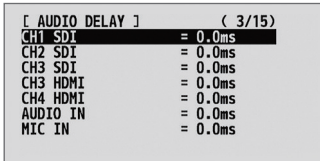

\* For more information about effects, refer to the following section.

2. Use the A/B fader to adjust the setting value.
3. Quit the menu (p. 12).

## Equalizer (EQ)

This adjusts the sound quality for each frequency band.

SDI 1 (page 4/15) – MIC IN (page 10/15)	
Menu item	Explanation
EQ Hi	This boosts or attenuates the high band.
EQ Hi FREQ	This adjusts the center frequency when changing the sound quality in the high band.
EQ Mid	This boosts or attenuates the middle band.
EQ Mid FREQ	This adjusts the center frequency when changing the sound quality in the middle band.
EQ Mid Q	This adjusts the width of the frequency band when boosting or attenuating the middle band.
EQ Lo	This boosts or attenuates the low band.
EQ Lo FREQ	This adjusts the center frequency when changing the sound quality in the low band.

## Delay (DELAY)

This outputs audio with a delay.

Delaying audio output lets you align the output timing of video and audio.

AUDIO DELAY (page 3/15)	
Menu item	Explanation
AUDIO DELAY	This adjusts the delay time for audio inputs.

## High-pass Filter (HPF)

This cuts off unneeded low-band audio. The cutoff frequency is 75 Hz.

MIC IN (page 10/15)	
Menu item	Explanation
HPF	This sets the high-pass filter on or off.

## Compressor (COMP)

This compresses audio that exceeds a specified level.

MIC IN (page 11/15)	
Menu item	Explanation
COMP	This sets the compressor on or off.
THRESHOLD	This sets the level used as the threshold when compressing audio. Compression is applied to audio that exceeds the level set here.
RATIO	This specifies the degree of compression applied to the audio. The state in which no compression is applied is defined as "1."
ATTACK	This sets the time until compression starts when audio exceeding the threshold is input.
RELEASE	This adjusts the length of time until compression ends after audio falls below the threshold.

## Gate (GATE)

This mutes audio that is below a specified level.

MIC IN (page 11/15)	
Menu item	Explanation
GATE	This sets gate on or off.
THRESHOLD	This sets the level used as the threshold for removing audio. Audio below the level set here is removed.
RELEASE	This adjusts the length of time until the audio is fully attenuated after audio falls below the threshold.

## Applying Effects to Output Audio

This applies effects and adjusts the sound quality for output audio.

1. Display the AUDIO menu (p. 12), then select the effect menu item you want to use.

[ AUDIO OUTPUT ] (12/15)	
EQ Hi	= 0dB
EQ Hi FREQ	= 8.00KHz
EQ Mid	= 0dB
EQ Mid FREQ	= 2.50KHz
EQ Mid Q	= 0.5
EQ Lo	= 0dB
EQ Lo FREQ	= 110Hz

\* For more information about effects, refer to the following section.

2. Use the A/B fader to adjust the setting value.
3. Quit the menu (p. 12).

## Equalizer (EQ)

This adjusts the sound quality for each frequency band.

MASTER OUT (page 12/15)	
Menu item	Explanation
EQ Hi	This boosts or attenuates the high band.
EQ Hi FREQ	This adjusts the center frequency when changing the sound quality in the high band.
EQ Mid	This boosts or attenuates the middle band.
EQ Mid FREQ	This adjusts the center frequency when changing the sound quality in the middle band.
EQ Mid Q	This adjusts the width of the frequency band when boosting or attenuating the middle band.
EQ Lo	This boosts or attenuates the low band.
EQ Lo FREQ	This adjusts the center frequency when changing the sound quality in the low band.

## Mastering (MASTERING)

This adjusts the acoustic characteristics and tone quality.

MASTER OUT (page 15/15)	
Menu item	Explanation
MASTERING	This switches mastering on and off.
NS	This adjusts the degree of application of the noise suppressor.
ENHANCER	This adjusts the degree of application of the enhancer.
Hi	This suppresses high-frequency distortion and adjusts the sound to have sustained tones.
Mid	This suppresses midrange distortion and adjusts the sound to have distinct tones.
Lo	This suppresses low-frequency distortion and adjusts the sound to have stable tones.

## Reverb (REVERB)

This adds lingering reverberations to the audio.

You can apply reverb to audio input via AUDIO IN, MIC, SDI IN, and HDMI IN.

MASTER OUT (page 13/15)	
Menu item	Explanation
LEVEL	This adjusts the return level from reverb of the audio. A setting of "0" results in no reverb applied.
TIME	This adjusts the length of the reverb.
TYPE	This specifies the type of reverb. ROOM: Produces the natural reverberations of a highly resonant room. HALL: Produces reverberations like that of a performance in a concert hall or other such space.

1. Display the AUDIO menu (p. 12), then select the input audio where you want to apply reverb using "REVERB SEND LEVEL."

[ AUDIO OUTPUT ] (14/15)	
REVERB SEND LEVEL	
CH1 SDI	= 100
CH2 SDI	= 100
CH3 SDI	= 100
CH3 HDMI	= 100
CH4 HDMI	= 100
AUDIO IN	= 100
MIC IN	= 100

2. Use the A/B fader to adjust the amount of audio sent to reverb.  
Repeat steps 1 and 2 as needed to individually adjust the amount of reverb applied.
3. At the AUDIO menu, select "LEVEL" under REVERB.

[ AUDIO OUTPUT ] (13/15)	
REVERB	
LEVEL	= 0
TIME	= 1.0sec
TYPE	= Room

4. Use the A/B fader to adjust the amount of audio returned from reverb.  
This adjusts the depth of overall reverb applied while maintaining the balance in the degree of reverb applied to the individual input audio streams.
5. Quit the menu (p. 12).

## Interlinking Audio Output to Video Switching (Audio Follow)

You can associate audio with a video switch so that when the video is switched, only the audio of the output video is output, and other audio is automatically muted.

You can also use Audio Follow with audio input via AUDIO IN or MIC.

1. Follow the procedure in "Adjusting the Volume Level" (p. 26) to adjust the volume to the level you want to output.
2. Display the AUDIO menu (p. 12), then select the input audio to use with Audio Follow.

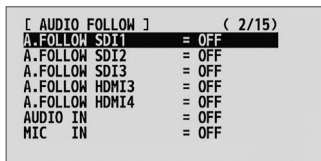

Menu item	Explanation
A. FOLLOW SDI 1-3	Input audio from SDI IN 1-3
A. FOLLOW HDMI 3, 4	Input audio from HDMI IN 3, 4

3. Use the A/B fader to set this to "ON."

Value	Explanation
ON	This sets the Audio Follow feature on. Audio is automatically muted when no video channel has been selected.
OFF	This sets the Audio Follow feature off.

4. Quit the menu (p. 12).

5. Switch the video.

On video channels where Audio Follow is on, audio is automatically muted when video on other channels is output.

\* Other settings are required to use Audio Follow with audio input via AUDIO IN or MIC. For details, refer to "Adding Audio Follow Associations" on this page.

### MEMO

- You can use the preview output from the MULTI-VIEW connector (four-way split screen) to check the Audio Follow settings. On video and audio channels where Audio Follow is on, "A.F" is displayed below the audio level meter.

## Adding Audio Follow Associations

You can use Audio Follow with audio input via AUDIO IN or MIC.

1. Display the AUDIO menu (p. 12), then select the input audio to use with Audio Follow.

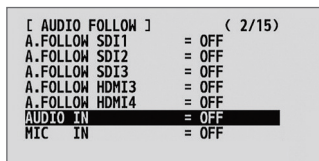

Menu item	Explanation
AUDIO IN	Input audio from AUDIO IN
MIC IN	Input audio from MIC

2. Use the A/B fader to specify the video channel to use with Audio Follow.

Value	Explanation
1-4	This sets the video input channel to interlink with input audio using Audio Follow. On the video channels other than the one specified, audio input via AUDIO IN or MIC is muted.
OFF	This assigns no video input channel to Audio Follow.

3. Quit the menu (p. 12).

# Other Features

## Returning Settings to the Factory-default State (Factory Reset)

You can return the values of settings on the V-1SD1 to their factory defaults.

If operation that differs from what is described in the Owner's Manual occurs even when the steps described are followed correctly, try performing a factory reset.

### NOTE

- Performing a factory reset causes all settings made and values saved in memory (p. 13) to be lost.

1. Display the SETUP menu (p. 12), then select "FACTORY RESET"

```
[ SYSTEM ] (16/16)
COLOR BAR OUTPUT = OFF
TEST TONE OUTPUT = OFF
A/B FADER CALIBRATE = ---
CAPTURE IMAGE = ---
RS-232 PANEL STATUS = OFF
FACTORY RESET = ---
VERSION 1.
```

2. Move the A/B fader to the bus A position.
3. Make sure the message "PRESS "UP"" is displayed, and press the [DSK] (▲) button. (If you want to cancel the operation, move the A/B fader to the bus B position or press the [AUTO] (▼) button.)  
A factory reset is executed.
4. Quit the menu (p. 12).

## Preventing Unintended Operation (Panel Lock)

This locks operation of buttons and knobs to prevent unintended operation of the V-1SD1.

1. Display the SETUP menu (p. 12), then select the targets for panel lock.

You can select the following menu items as targets for panel lock.

PANEL LOCK (page 10/16)	
Menu item	Target of panel lock
ALL SW & VOLUME	All controls listed at the PANEL LOCK menu item
RIGHT SW	The following buttons on the right side of the panel
DSK SW	[DSK] button
AUTO SW	[AUTO] button
LEFT SW	The following buttons on the left side of the panel
FREEZE SW	[FREEZE] button
MEMORY SW	[MEMORY] button
AUDIO SW	[AUDIO] button
PANEL LOCK (page 11/16)	
CENTER SW	The following buttons at the center of the panel
A/B BUS SW	[A-1]–[A-4] buttons [B-1]–[B-4] buttons
KEY LEVEL SW	[KEY LEVEL] button
WIPE SW	[WIPE] button
MIX SW	[MIX] button
CUT SW	[CUT] button
PinP SW	[PinP] button
SPLIT SW	[SPLIT] button
PANEL LOCK (page 12/16)	
VOLUME	The following knobs and the A/B fader
OUTPUT FADE VOL	[OUTPUT FADE] knob
CONTROL 1 VOL	[CONTROL 1] knob
CONTROL 2 VOL	[CONTROL 2] knob
A/B FADER	A/B fader

2. Use the A/B fader to set panel lock to enabled (ON) or disabled (OFF).
3. Quit the menu (p. 12).

The SETUP indicator lights up when an attempt is made to operate a button, knob, or other control for which panel lock is enabled.

## Operating the V-1SDI by Remote Control

You can use V-1SDI RCS dedicated software to remotely control the following functions on the V-1SDI from a computer connected via USB.

- V-1SDI panel operations
- Selecting transition effects
- Audio mixer operation
- Memory save/load operations
- Transmission of still images

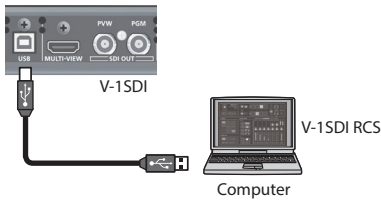

V-1SDI RCS can be downloaded from the following Roland website.

<https://proav.roland.com/>

## About Remote Control Via MIDI or RS-232

The V-1SDI also supports remote control by external equipment via MIDI or RS-232.

For information on remote control via MIDI or RS-232, refer to the “Reference Manual” (PDF) available for download at the Roland website above.

# Appendices

## Troubleshooting

If you suspect a malfunction, please check the following points. If this does not resolve the problem, contact a nearby Roland Service Center.

Problem	Items to check	Action	Page
<b>Video-related problems</b>			
<b>No picture is input.</b>	Are the [A-1] through [A-4] and [B-1] through [B-4] buttons flashing in white?	Video whose format differs from the setting on the V-1SDI is input. Input video that is compatible with the specified format.	p. 14
	Is copyright-protected (HDCP) video being input?	When inputting copyright-protected (HDCP) video signals, go to the SETUP menu and set "HDCP" to "ON."	p. 17
<b>Video from the computer is not displayed.</b>	Is the format of the video output from the computer compatible with the V-1SDI's input formats?	The supported input formats on channels 1 through 3 are 1080p, 1080i, and 720p. Only channel 4 supports VESA-standard resolutions.	p. 14
<b>No picture is output.</b>	Has the [OUTPUT FADE] knob been turned clockwise or counterclockwise?	By default, turning the [OUTPUT FADE] knob clockwise or counterclockwise applies a fade to the main output video. When outputting video, adjust the [OUTPUT FADE] knob to its center position.	p. 21
	Is the display connected correctly?	When outputting copyright-protected (HDCP) video, connect an HDCP-compatible display.	—
	Is the SETUP menu item "HDCP" set to "ON"?	When "HDCP" is set to "ON," video is output only from the MULTI-VIEW connector. No video is output from the PWV and PGM connectors.	p. 17
<b>"Snowy"-noise video is output.</b>	It is possible that the HDMI signal is not being sent and received correctly.	Reconnect the HDMI cable.	—
<b>The colors on the monitor screen connected via HDMI are incorrect.</b>	Does the color space setting for the monitor connected to the MULTI-VIEW connector match the color space setting on the V-1SDI?	Go to the SETUP menu and make the setting for "COLOR SPACE."	p. 15
		Depending on the device, the color space might be interlinked with the selection of DVI or HDMI or the selected format. In such cases, changing the color space on the output device might bring about improvement for the problem.	—
<b>The edges of video shown on the display are cut off.</b>	Are the display settings compatible?	Depending on the device, the display might automatically overscan. Change the display's settings.	—
<b>Compositing a logo or image is not possible.</b>	Has the correct extraction color been selected by DSK?	<ul style="list-style-type: none"> <li>Use the SETUP menu item "KEY TYPE" to select an extraction color for when compositing that matches the background color of the logo or image.</li> <li>Use the [CONTROL 1] and [CONTROL 2] knobs to adjust the position to just the right degree of extraction for the logo or image.</li> </ul>	p. 24
<b>Audio-related Problems</b>			
<b>No audio is output. Audio volume is low.</b>	Is the volume turned down on the connected amplifications or speakers?	Adjust to an appropriate volume level.	—
	Is the volume turned down on the V-1SDI?	Adjust each input-audio stream to an appropriate volume level. Also, adjust the overall volume level.	p. 26
<b>No reverb is applied.</b>	Are you using connection cables that contain resistors?	If this happens, use connector cables that do not contain resistors.	—
	Is the amount of audio sent to Reverb set at an appropriate level?	If the send level for audio to Reverb is too low, the amount of reverb effect might be difficult to discern. Adjust the send level of the audio to Reverb.	p. 28



# Transition Effects List

## MIX



Effect	Explanation
MIX	The two pictures are blended together as the video is switched.
FAM	Video transitions are made with the luminance levels of the two video streams maintained unchanged. * This is an abbreviation of "full additive mix."
NAM	The two video streams are compared, and transitions are made with display during transition starting with levels of high luminance. * This is an abbreviation of "non-additive mix."
MOSAIC	Transitions are made with mosaic pixelation.

## WIPE

The original video is broken into by the next video.

### Normal

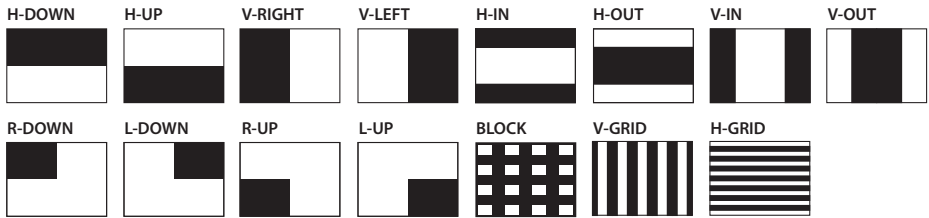

### Soft Edge

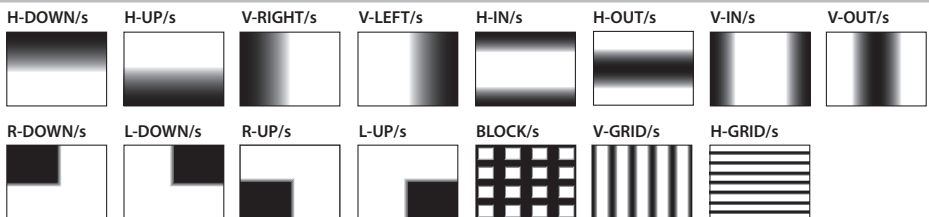

# Block Diagram

## Video Block

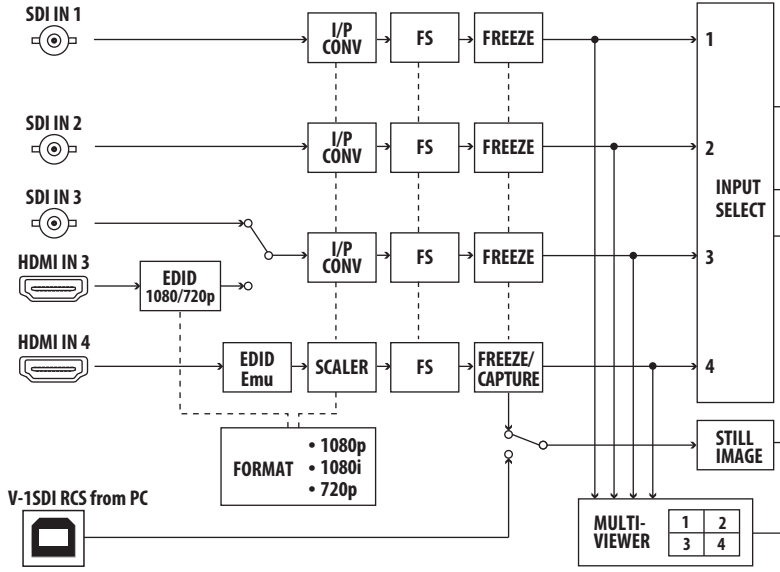

## Audio Block

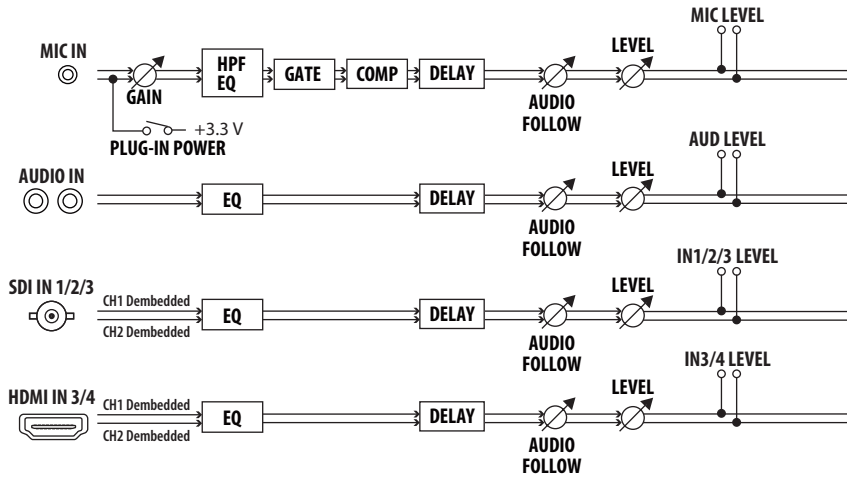

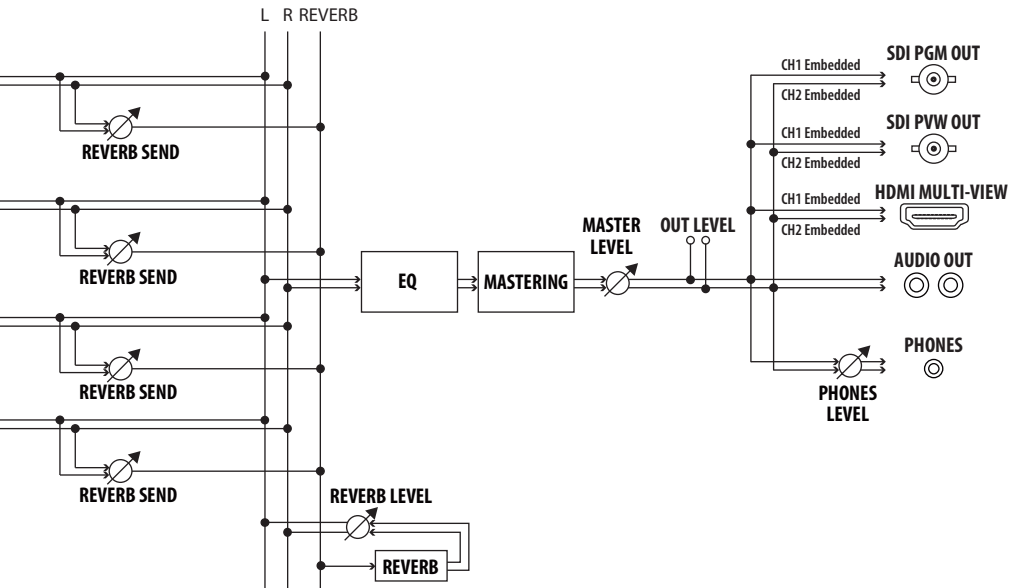
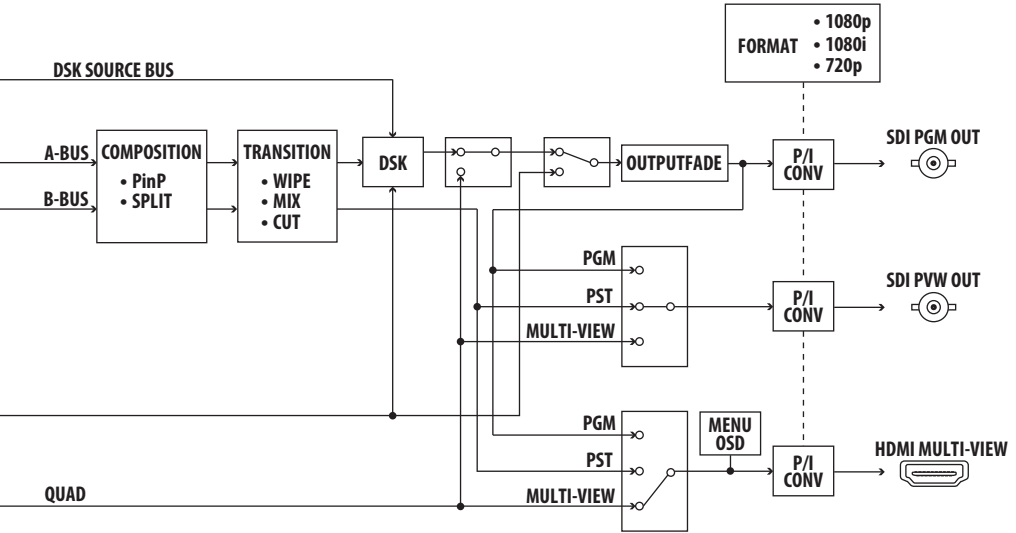

# Main Specifications

Roland V-1SDI: 3G-SDI Video Switcher

■ Video		
<b>Video Processing</b>	4:2:2 (Y/Pb/Pr), 8-bit	
<b>Input Connectors</b>	SDI INPUT 1–3	BNC x 3 * Conforms to SMPTE 424M (SMPTE 425M-AB), 292M
	HDMI INPUT 3–4	Type A (19 pins) x 2 * HDCP Supported * INPUT 3: SDI or HDMI selected.
<b>Output Connectors</b>	SDI OUT PGM	BNC x 1 * Conforms to SMPTE 424M (SMPTE 425M-AB), 292M
	SDI OUT PVW	BNC x 1 * Conforms to SMPTE 424M (SMPTE 425M-AB), 292M
	HDMI OUT MULTI-VIEW	Type A (19 pins) x 1 * HDCP Supported
<b>Input formats (*1) (*2)</b>	SDI INPUT 1–3 (*3) HDMI INPUT 3	720/59.94p, 720/50p (FORMAT switch = 720p) 1080/59.94i, 1080/50i 1080/59.94p, 1080/50p (FORMAT switch = 1080i or 1080p)
	HDMI INPUT 4	480/59.94i, 576/50i, 480/59.94p, 576/50p, 720/59.94p, 720/50p, 1080/59.94i, 1080/50i, 1080/59.94p, 1080/50p, VGA (640 x 480/60 Hz), SVGA (800 x 600/60 Hz), XGA (1024 x 768/60 Hz), WXGA (1280 x 768/60 Hz), SXGA (1280 x 1024/60 Hz), FWXGA (1366 x 768/60 Hz), SXGA+ (1400 x 1050/60 Hz), UXGA (1600 x 1200/60 Hz), WUXGA (1920 x 1200/60 Hz) * The refresh rate is the maximum value of each resolution. * Conforms to VESA DMT Version 1.0 Revision 11. * 1920 x 1200/60 Hz: Reduced blanking
<b>Output formats (*2)</b>	SDI OUT PGM (*3)	720/59.94p, 720/50p (FORMAT switch = 720p)
	SDI OUT PVW (*3)	1080/59.94i, 1080/50i (FORMAT switch = 1080i)
	HDMI OUT MULTI-VIEW	1080/59.94p, 1080/50p (FORMAT switch = 1080p)
<b>Video Effects</b>	Transition	CUT, MIX (DISSOLVE/FAM/NAM/MOSAIC), WIPE (30 types)
	Composition	PinP, SPLIT, QUAD, DSK (Luminance Key, Chroma Key)

\*1: The input interlaced video signal is converted to progressive video signal by internal processing.

\*2: The video signal frame rate can be selected at the SETUP menu (59.94 or 50).

\*3: Conforms to SMPTE 296M, SMPTE 274M

■ Audio		
<b>Audio Processing</b>	Sampling rate	24 bits/48 kHz
<b>Audio formats</b>	SDI	Linear PCM, 24 bits/48 kHz, 2ch * Conforms to SMPTE 299M
	HDMI	Linear PCM, 24 bits/48 kHz, 2ch
<b>Input Connectors</b>	Digital	SDI INPUT 1–3 (BNC) x 3 HDMI INPUT 3–4 (HDMI Type A 19 pins) x 2
	Analog	AUDIO IN (RCA phono type) MIC (Stereo mini type, plug-in power supported)
<b>Output Connectors</b>	Digital	SDI OUT PGM: BNC x 1 SDI OUT PVW: BNC x 1 HDMI OUT MULTI-VIEW: Type A (19 pins) x 1
	Analog	AUDIO OUT (RCA phono type) PHONES (Stereo mini type)
<b>Input Level</b>	AUDIO IN	-10 dBu (Maximum: +8 dBu)
	MIC	-41 – -13 dBu (Maximum: -1 dBu)
<b>Input Impedance</b>	AUDIO IN	15 k ohms
	MIC	10 k ohms
<b>Output Level</b>	AUDIO OUT	-10 dBu (Maximum: +8 dBu)
	PHONES	92 mW + 92 mW (32 ohms)
<b>Output Impedance</b>	AUDIO OUT	1k ohms
	PHONES	10 ohms
<b>Audio Effects</b>	EQ, Delay, Compressor, HPF, Gate, Reverb, Mastering effect	

<b>Other Connectors</b>	
USB	B Type (for remote control from PC)
RS-232	DB-9 type
<b>Other Functions</b>	
MEMORY (8 types), FREEZE (input video captured), OUTPUT FADE (Audio, Video: WHITE or BLACK)	
<b>Others</b>	
Power Supply	AC Adaptor
Current Draw	2.1 A
Power Consumption	25 W
Operation Temperature	+0 to +40 degrees Celsius +32 to +104 degrees Fahrenheit
Dimensions	313 (W) x 108 (D) x 59 (H) mm 12-1/3 (W) x 4-1/4 (D) x 2-1/3 (H) inches
Weight	1.2 kg 2 lbs 10-2/5 oz
Accessories	Owner's Manual, AC adaptor, Power cord, Cord hook

\* 0 dBu=0.775 Vrms

\* This document explains the specifications of the product at the time that the document was issued. For the latest information, refer to the Roland website.

## Dimensions

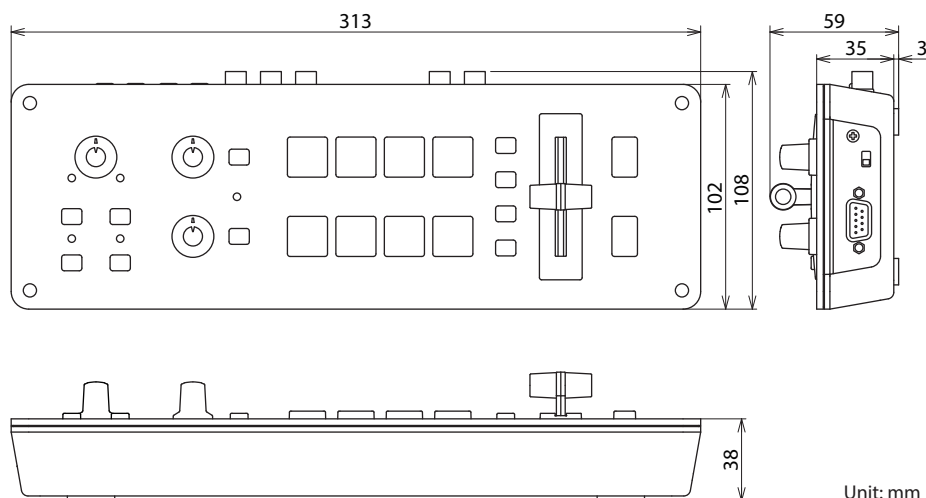

Unit: mm

For the U.K.

**IMPORTANT:** THE WIRES IN THIS MAINS LEAD ARE COLOURED IN ACCORDANCE WITH THE FOLLOWING CODE.

**BLUE:** NEUTRAL  
**BROWN:** LIVE

As the colours of the wires in the mains lead of this apparatus may not correspond with the coloured markings identifying the terminals in your plug, proceed as follows:

The wire which is coloured BLUE must be connected to the terminal which is marked with the letter N or coloured BLACK. The wire which is coloured BROWN must be connected to the terminal which is marked with the letter L or coloured RED. Under no circumstances must either of the above wires be connected to the earth terminal of a three pin plug.

For the USA

### DECLARATION OF CONFORMITY Compliance Information Statement

Model Name : V-1SDI  
Type of Equipment : VIDEO SWITCHER  
Responsible Party : Roland Corporation U.S.  
Address : 5100 S. Eastern Avenue Los Angeles, CA 90040-2938  
Telephone : (323) 890-3700

For the USA

### FEDERAL COMMUNICATIONS COMMISSION RADIO FREQUENCY INTERFERENCE STATEMENT

This equipment has been tested and found to comply with the limits for a Class B digital device, pursuant to Part 15 of the FCC Rules. These limits are designed to provide reasonable protection against harmful interference in a residential installation. This equipment generates, uses, and can radiate radio frequency energy and, if not installed and used in accordance with the instructions, may cause harmful interference to radio communications. However, there is no guarantee that interference will not occur in a particular installation. If this equipment does cause harmful interference to radio or television reception, which can be determined by turning the equipment off and on, the user is encouraged to try to correct the interference by one or more of the following measures:

- Reorient or relocate the receiving antenna.
- Increase the separation between the equipment and receiver.
- Connect the equipment into an outlet on a circuit different from that to which the receiver is connected.
- Consult the dealer or an experienced radio/TV technician for help.

This device complies with Part 15 of the FCC Rules. Operation is subject to the following two conditions:

- (1) this device may not cause harmful interference, and
- (2) this device must accept any interference received, including interference that may cause undesired operation.

This equipment requires shielded interface cables in order to meet FCC class B limit.

Any unauthorized changes or modifications not expressly approved by the party responsible for compliance could void the user's authority to operate the equipment.

For Canada

CAN ICES-3 (B)/NMB-3 (B)

For Korea

### 사용자 안내문

기종별	사용자 안내문
B 급 기기 (가정용 방송통신기자재)	이 기기는 가정용(B 급) 전자파적합기기로서 주로 가정에서 사용하는 것을 목적으로 하며, 모든지역에서 사용할 수 있습니다.

Manufacturer: 2036-1 Nakagawa, Hosoe-cho, Kita-ku, Hamamatsu, Shizuoka 431-1304, JAPAN  
Importer: ENA 23 Zone 1 nr. 1620 Klaus-Michael Kuehnelaan 13, 2440 Geel, BELGIUM



## For EU Countries



**UK** This symbol indicates that in EU countries, this product must be collected separately from household waste, as defined in each region. Products bearing this symbol must not be discarded together with household waste.

**DE** Dieses Symbol bedeutet, dass dieses Produkt in EU-Ländern getrennt vom Hausmüll gesammelt werden muss gemäß den regionalen Bestimmungen. Mit diesem Symbol gekennzeichnete Produkte dürfen nicht zusammen mit den Hausmüll entsorgt werden.

**FR** Ce symbole indique que dans les pays de l'Union européenne, ce produit doit être collecté séparément des ordures ménagères selon les directives en vigueur dans chacun de ces pays. Les produits portant ce symbole ne doivent pas être mis au rebut avec les ordures ménagères.

**IT** Questo simbolo indica che nei paesi della Comunità europea questo prodotto deve essere smaltito separatamente dai normali rifiuti domestici, secondo la legislazione in vigore in ciascun paese. I prodotti che riportano questo simbolo non devono essere smaltiti insieme ai rifiuti domestici. Ai sensi dell'art. 13 del D.Lgs. 25 luglio 2005 n. 151.

**ES** Este símbolo indica que en los países de la Unión Europea este producto debe recogerse aparte de los residuos domésticos, tal como está regulado en cada zona. Los productos con este símbolo no se deben depositar con los residuos domésticos.

**PT** Este símbolo indica que nos países da UE, a recolha deste produto deverá ser feita separadamente do lixo doméstico, de acordo com os regulamentos de cada região. Os produtos que apresentem este símbolo não deverão ser eliminados juntamente com o lixo doméstico.

**NL** Dit symbool geeft aan dat in landen van de EU dit product gescheiden van huishoudelijk afval moet worden aangeboden, zoals bepaald per gemeente of regio. Producten die van dit symbool zijn voorzien, mogen niet samen met huishoudelijk afval worden verworpen.

**DK** Dette symbol angiver, at i EU-lande skal dette produkt opsamlles adskilt fra husholdningsaffald, som defineret i hver enkelt region. Produkter med dette symbol må ikke smides ud sammen med husholdningsaffald.

**NO** Dette symbolet indikerer at produktet må behandles som spesialavfall i EU-land, iht. til retningslinjer for den enkelte regionen, og ikke kastes sammen med vanlig husholdningsavfall. Produkter som er merket med dette symbolet, må ikke kastes sammen med vanlig husholdningsavfall.

**SE** Symbolen anger att i EU-länder måste den här produkten kasseras separat från hushållsavfall, i enlighet med varje regions bestämmelser. Produkter med den här symbolen får inte kasseras tillsammans med hushållsavfall.

**FI** Tämä merkinäyttö ilmaisee, että tuote on EU-maissa kerättävä erillään kotitalousjätteistä kunkin alueen voimassa olevien määräysten mukaisesti. Tällä merkinäytöllä varustettuja tuotteita ei saa hävittää kotitalousjätteen mukana.

**HU** Ez a szimbólum azt jelenti, hogy az Európai Unióban ezt a terméket a háztartási hulladéktól elkülönítve, az adott régióban érvényes szabályozás szerint kell gyűjtetni. Az ezzel a szimbómmal ellátott termékeket nem szabad a háztartási hulladékok közé dobni.

**PL** Symbol oznacza, że zgodnie z regulacjami w odpowiednim regionie, w krajach UE produktu nie należy wyrzucać z odpadami domowymi. Produktów opatrzonych tym symbolem nie można utylizować razem z odpadami domowymi.

**CZ** Tento symbol udává, že v zemích EU musí být tento výrobek sbíráán odděleně od domácího odpadu, jak je určeno pro každý region. Výrobky nesoucí tento symbol se nesmí vyhazovat spolu s domácím odpadem.

**SK** Tento symbol vyjadruje, že v krajinách EÚ sa musí zber tohto produktu vykonávať oddelene od domového odpadu, podľa nariadení platných v konkrétnej krajine. Produkty s týmto symbolom sa nesmú vyhazovať spolu s domovým odpadom.

**EE** See sümbol näitab, et EL-i maades tuleb see toode olemprigist eraldi koguda, nii nagu on igas piirkonnas määratletud. Selle sümboliga märgitud tooteid ei tohi ära visata koos olmeprügiga.

**LT** Šis simbolis rodo, kad ES šalyse šis produktas turi būti surenkamas atskirai nuo buitinių atliekų, kaip nustatyta kiekviename regione. Šiuo simboliu paženklinoti produktai neturi būti išmetami kartu su buitinėmis atliekomis.

**LV** Šis simbols norāda, ka ES valstīs šo produktu jāievāc atsevišķi no mājsaimeniecības atkritumiem, kā noteikts katrā reģionā. Produkts ar šo simbolu nedrīkst izmest kopā ar mājsaimeniecības atkritumiem.

**SI** Ta simbol označuje, da je treba proizvo v državih EU zbirati ločeno od gospodinskih odpadkov, tako kot je določeno v vsaki regiji. Proizvoda s tem znakom ni dovoljeno odlagati skupaj z gospodinskimi odpadki.

**GR** Το σύμβολο αυτό υποδηλώνει ότι στις χώρες της Ε.Ε. το συγκεκριμένο προϊόν πρέπει να συλλέγεται χωριστά από τα υπόλοιπα οικιακά απορρίμματα, σύμφωνα με όσα προβλέπονται σε κάθε περιοχή. Τα προϊόντα που φέρουν το συγκεκριμένο σύμβολο δεν πρέπει να απορρίπτονται μαζί με τα οικιακά απορρίμματα.

## For China

### 有关产品中所含有害物质的说明

本资料就本公司产品中所含的特定有害物质及其安全性予以说明。

本资料适用于2007年3月1日以后本公司所制造的产品。

### 环保使用期限



此标志适用于在中国国内销售的电子信息产品，表示环保使用期限的年数。所谓环保使用期限是指在自制造日起的规定期限内，产品中所含的有害物质不致引起环境污染，不会对人身、财产造成严重的不良影响。

环保使用期限仅在遵照产品使用说明书，正确使用产品的条件下才有效。不当的使用，将会导致有害物质泄漏的危险。

### 产品中有毒有害物质或元素的名称及含量

部件名称	有毒有害物质或元素					
	铅(Pb)	汞(Hg)	镉(Cd)	六价铬(Cr(VI))	多溴联苯(PBB)	多溴二苯醚(PBDE)
外壳(壳体)	X	○	○	○	○	○
电子部件(印刷电路板等)	X	○	X	○	○	○
附件(电源线、交流适配器等)	X	○	○	○	○	○

○：表示该有毒有害物质在该部件所有均质材料中的含量均在 SJ/T11363-2006 标准规定的限量要求以下。  
X：表示该有毒有害物质至少在该部件的某一均质材料中的含量超出 SJ/T11363-2006 标准规定的限量要求。因根据现有的技术水平，还没有什么物质能够代替它。



### Intellectual Property Right

- It is forbidden by law to make an audio recording, video recording, copy or revision of a third party's copyrighted work (musical work, video work, broadcast, live performance, or other work), whether in whole or in part, and distribute, sell, lease, perform or broadcast it without the permission of the copyright owner.
- Do not use this product for purposes that could infringe on a copyright held by a third party. We assume no responsibility whatsoever with regard to any infringements of third-party copyrights arising through your use of this product.
- This product can be used to record or duplicate audio or visual material without being limited by certain technological copy-protection measures. This is due to the fact that this product is intended to be used for the purpose of producing original music or video material, and is therefore designed so that material that does not infringe copyrights belonging to others (for example, your own original works) can be recorded or duplicated freely.
- This product contains eParts integrated software platform of eSOL Co.,Ltd. eParts is a trademark of eSOL Co., Ltd. in Japan.
- Roland is an either registered trademark or trademark of Roland Corporation in the United States and/or other countries.
- Company names and product names appearing in this document are registered trademarks or trademarks of their respective owners.

